

# TOSHIBA



## PORTABLE DVD PLAYER

# SD-P2600

### OWNER'S MANUAL



Introduction 2

Basic playback 19

Advanced playback 43

Quick control 51

Function setup 65

Connections 77

Others 89

# SAFETY PRECAUTIONS

**CAUTION:** This equipment employs a Laser System.  
To ensure proper use of this product, please read this owner's manual carefully and retain for future reference. Should the unit require maintenance, contact an authorized service location - see service procedure.

Use of controls or adjustments or performance of procedures other than those specified herein may result in hazardous radiation exposure.

To prevent direct exposure to laser beam, do not try to open the enclosure.  
Visible and invisible laser radiation when open and interlocks defeated.  
**DO NOT STARE INTO BEAM.**



**FCC NOTICE “Declaration of Conformity Information”**

This equipment has been tested and found to comply with the limits for a Class B digital device, pursuant to part 15 of the FCC Rules. These limits are designed to provide reasonable protection against harmful interference in a residential installation.

This equipment generates, uses and can radiate radio frequency energy and, if not installed and used in accordance with the instructions, may cause harmful interference to radio communications.

However, there is no guarantee that interference will not occur in a particular installation.

If this equipment does cause harmful interference to radio or television reception, which can be determined by turning the equipment off and on, the user is encouraged to try to correct the interference by one or more of the following measures:

- Reorient or relocate the receiving antenna.
- Increase the separation between the equipment and receiver.
- Connect the equipment into an outlet on a circuit different from that to which the receiver is connected.
- Consult the dealer or an experienced radio/TV technician for help.

**WARNING:** Only peripherals complying with the FCC class B limits may be attached to this equipment. Operation with non-compliant peripherals or peripherals not recommended by Toshiba is likely to result in interference to radio and TV reception. Changes or modifications made to this equipment, not expressly approved by Toshiba, or parties authorized by Toshiba, could void the user's authority to operate the equipment.

This device complies with part 15 of the FCC Rules. Operation is subject to the following two conditions:

- (1) This device may not cause harmful interference, and
- (2) this device must accept any interference received, including interference that may cause undesired operation.

**CAUTION:** These servicing instructions are for use by qualified service personnel only. To reduce the risk of electric shock do not perform any servicing other than that contained in the operating instructions unless you are qualified to do so.

**WARNING:** Handling the cord on this product or cords associated with accessories sold with this product, will expose you to lead, a chemical known to the State of California to cause birth defects or other reproductive harm. ***Wash hands after handling.***



In the spaces provided below, record the Model and Serial No. located on the bottom of your player.

Model No. \_\_\_\_\_

Serial No. \_\_\_\_\_

Retain this information for future reference.

**Location of the required label**

<b>TOSHIBA</b>	
PORTABLE DVD PLAYER    MODEL NO. SD-P2600	
DC 12V  3A	PRODUCT IS CERTIFIED BY THE MANUFACTURER TO COMPLY WITH DHHS RULE 21 CFR SUBCHAPTER J APPLICABLE AT THE DATE OF MANUFACTURE.
 Tested To Comply With FCC Standards FOR HOME OR OFFICE USE	MANUFACTURED
	SERIAL NO.
<b>TOSHIBA CORPORATION</b> MADE IN CHINA	
1-1, SHIBAURA 1-CHOME, MINATO-KU, TOKYO 105-8001, JAPAN    FABRIQUE EN CHINE	
THIS CLASS B DIGITAL APPARATUS COMPLIES WITH CANADIAN ICE-003. CET APPAREIL NUMERIQUE DE LA CLASSE B EST CONFORME A LA NORME NMB-003 DU CANADA.	

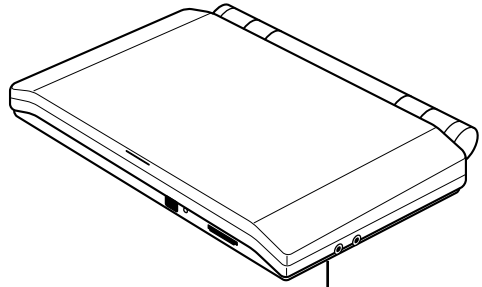

# IMPORTANT SAFETY INSTRUCTIONS

**CAUTION: PLEASE READ AND OBSERVE ALL WARNINGS AND INSTRUCTIONS GIVEN IN THIS OWNER'S MANUAL AND THOSE MARKED ON THE UNIT. RETAIN THIS BOOKLET FOR FUTURE REFERENCE.**

This set has been designed and manufactured to assure personal safety. Improper use can result in electric shock or fire hazard. The safeguards incorporated in this unit will protect you if you observe the following procedures for installation, use and servicing. This unit is fully transistorized and does not contain any parts that can be repaired by the user.

**DO NOT REMOVE THE CABINET COVER, OR YOU MAY BE EXPOSED TO DANGEROUS VOLTAGE. REFER SERVICING TO QUALIFIED SERVICE PERSONNEL ONLY.**

1. Read these instructions.
2. Keep these instructions.
3. Heed all warnings.
4. Follow all instructions.
5. Do not use this apparatus near water.
6. Clean only with dry cloth.
7. Do not install near any heat sources such as radiators, heat registers, stoves, or other apparatus (including amplifiers) that produce heat.
8. Do not insert any foreign objects into the memory card slot. Heat build-up or fire may result.
9. Protect the power cord from being walked on or pinched particularly at plugs, convenience receptacles, and the point where they exit from the apparatus.
10. Only use attachments/accessories specified by the manufacturer.
11. Unplug this apparatus during lightning storms or when unused for long periods of time. However, while it is thundering or lightning, do not touch the apparatus and any connected cable and/or equipment. This will prevent you from receiving the electric shock by an electric surge.
12. Refer all servicing to qualified service personnel. Servicing is required when the apparatus has been damaged in any way, such as power-supply cord or plug is damaged, liquid has been spilled or objects have fallen into the apparatus, the apparatus has been exposed to rain or moisture, does not operate normally, or has been dropped.

## ADDITIONAL SAFETY INSTRUCTIONS

13. When you use headphones, keep the volume at a moderate level. If you use the headphones continuously with high volume sound, it may cause hearing damaged.
14. Do not overload wall outlets; extension cords, or integral convenience receptacles as this can result in a risk of fire or electric shock.
15. Apparatus shall not be exposed to dripping or splashing and no objects filled with liquids, such as vases, shall be placed on the apparatus and/or around it.
16. Be careful not to catch your fingers in the disc holder when closing the lid. It may cause personal injury.
17. Do not put a vessel containing liquid such as a vase, or a metal object on the apparatus. If liquid or a foreign metal object is let into the apparatus, it may cause fires or electric shock.
18. Do not use a cracked, deformed, or repaired disc. These discs are easily broken and may cause serious personal injury and apparatus malfunction.
19. Do not touch a spinning disc. When you open the disc holder, the disc may have not stopped spinning. Touching a spinning disc may cause personal injury or damage to the product.
20. Do not rest the product on your lap or other parts of body, as it may become heated. Even low temperature may cause inflaming or blistering, if touched for a prolonged period.
21. Use the supplied AC adapter to operate the product. Substitute devices not specified by the manufacturer may result in fire or product malfunction. Do not cover the AC adapter with a blanket or place it near heating or on electric carpet when it is in use.

22. When you use this product in an airplane, follow the instructions of the airline. Disregarding them may cause harmful interference to radio communication.
23. Do not look close to the pick-up lens or stare into laser beam. Doing so may cause damage to eyesight.
24. Do not use this product while walking or driving. Neglecting this may cause a traffic accident.
25. Should the LCD monitor be broken and liquid leaks out, do not inhale or swallow it. Doing so may cause poisoning.  
If you have got it into your mouth, wash it out and consult your doctor. If your hands or clothes have touched it, wipe them with alcohol and a cleaning cloth and then wash them well.
26. Do not allow children to scratch, lick or put the memory card into their mouth.  
Keep the memory card out of the reach of children. Injury to the child or malfunction may result.
27. Battery Pack
- a) Never throw the battery pack into a fire, as that could cause the battery pack to explode. Never heat the battery pack, as that could cause leakage of alkaline solution or other electrolytic substance.
  - b) Never disassemble the battery pack, as that could cause leakage of alkaline solution or other electrolytic substance.
  - c) Never short-circuit the battery pack by either accidentally or intentionally bringing the terminals in contact with another metal object. This could cause personal injury or a fire, and could also damage the battery pack.
  - d) Never drive a nail into the battery pack. Never strike the battery pack with a hammer. Never step or tread on the battery pack.
  - e) If you ever detect the emission of an extraordinary odor, excessive heat, discoloration, or deformation of the battery pack, remove it from the player after confirming safety, and discontinue use of it. Take the battery pack to an authorized Toshiba service provider.
  - f) Keep the battery pack away from heat or fire, if you detect the emission of an extraordinary odor or leakage of alkaline solution or other electrolytic substance.
- g) Never dispose of used battery packs with other ordinary solid wastes, since they contain toxic substances. Always dispose of used battery packs in accordance with community regulations that apply to the disposal of batteries. Cover the metal terminals with insulating tape, in order to prevent accidental short-circuiting.
  - h) Always confirm that the battery pack is compatible with your player, before attaching the battery pack to the player.
  - i) Never expose the terminals of the battery pack to any other metal object. Wrap the battery or place it in a protective plastic bag, whenever transporting it.
  - j) Always confirm that the temperature is between 5 and 35°C (41°F and 95°F) before you charge the battery. Leakage, excessive heat, or deterioration of the battery pack may occur if this warning is not heeded.
  - k) Never immerse the battery pack in any liquid.
  - l) Never expose the battery pack to direct sunlight. Never store or use the battery pack in a locked and unventilated vehicle. (where excessive internal temperatures may be encountered.)
  - m) Always keep the battery pack out of reach of infants or small children.
  - n) Never shock the battery pack by dropping or throwing it.
  - o) If the liquid contained within the battery pack leaks, use a large amount of water and immediately wash off any liquid which may accidentally contact any part of the body. Remove any liquid that has contacted your clothing by washing it immediately with a detergent.
  - p) Always confirm that a “click” sound has resulted, when attaching the battery pack to the player. This sound confirms that the battery pack has been properly attached.
28. Coin-shaped Battery
- a) Keep coin-shaped batteries out of children’s reach. Be careful not to ingest internally, especially by children, as doing so may cause poisoning.
  - b) Do not load a battery into the remote control with the wrong side out.
  - c) Do not charge, heat, open, or short-circuit the batteries. Do not throw the batteries into a fire.

# IMPORTANT SAFETY INSTRUCTIONS

- d) Do not leave a dead or exhausted battery in the remote control.
- e) If you do not use the remote control for a long period of time, remove the battery to avoid possible damage from battery corrosion.
29. After unpacking coin-shaped batteries, store them in poly bags, etc. separately one by one when unused. If you leave them unwrapped, they may be short-circuited by contact with metal objects, resulting in battery leakage, heat or bursting. This may cause burns or injury.  
The batteries must be completely discharged when they are deposited in collection containers for old batteries. If a charge remains, countermeasures to prevent short circuits must be taken.
30. To reduce the risk of fire or electric shock, do not expose this apparatus to rain or moisture.
31. Following mark means "CAUTION - RISK OF ELECTRIC SHOCK - DO NOT OPEN".



32. Vehicle adapter and operation in a car
- a) NEVER operate the apparatus or view a DVD Video while operating an automobile or other vehicle. Note: doing so is illegal in many jurisdictions.  
NEVER place a apparatus within the eyesight of a driver while he/she is driving an automobile/vehicle. Note: an apparatus located in the front seating section of a vehicle is illegal in many jurisdictions.  
Failure to observe the above instructions could result in the driver's inattention to and/or distraction from road hazards.
- b) NEVER place an apparatus in a location where it could interfere with the proper deployment and/or performance of an air bag. Failure to observe this instruction could result in the prevention of an air bag to properly and/or effectively deploy.
- c) Do not use a vehicle adapter other than the model supplied, to power the apparatus. Do not use the supplied vehicle adapter to power an apparatus other than this apparatus. Neglecting these may cause smoke, fire or electrical shock to human body.
- d) This adapter is intended for exclusive use in automobiles/vehicles with a DC 12V negative ground electrical system.  
NEVER use this adapter with a DC 24V configured automobile/vehicle.  
Consult your vehicle owner's manual before using this adapter.
- e) When handling, using or storing the adapter power cord NEVER:
- Place or locate near any apparatus that produces heat.
  - Disassemble, splice or extend the cord.
  - Pull, force or place any heavy objects on the cord.
  - Bend, twist or bind the cord.
- f) Keep away from the driving device (such as brake pedal, etc.) and the moving equipment (such as a seat rail, car windows, door, etc.).
- g) NEVER disassemble or alter this adapter in any manner.
- h) ALWAYS use caution when touching the adapter, cigarette lighter socket or power port. The adapter, lighter socket and power port may become heated after prolonged use.
- i) ALWAYS remove the adapter from the cigarette lighter socket or power port when not in use.
- j) Do not charge the battery pack which is attached to the apparatus by the adapter. Doing so may cause smoke, fire or electrical shock to human body. Whenever you use the adapter, be sure to remove the battery pack from the apparatus to prevent it from being charged by the adapter.
- k) Some cars may not have a compatible socket. NEVER modify this adapter to fit an incompatible cigarette lighter socket and/or power port. NEVER modify an incompatible cigarette lighter socket and/or power port to accept this adapter.  
Failure to observe the above warnings could cause smoke, fire, burns and/or electric shock.
- l) ALWAYS locate the apparatus on a level and secure surface. If placed on an uneven, shaky, unsecured or unstable surface, apparatus may fall.  
Failure to observe the above warning could result in the apparatus striking a person.
- m) When using the adapter, insert the plug of the adapter into the cigarette lighter socket or power port fully.  
The incomplete insertion will cause smoke or fire.
- n) Do not touch the adapter with wet hands. Do not liquid over the adapter.

## Notes on handling

- Do not shock the LCD monitor. It may cause unit damage and malfunction.
- Do not use the player in a place subject to vibration. Neglecting this may cause malfunction of the player or damage to the disc.
- Do not leave the player in a vehicle. Rise or drop in temperature may result in malfunction of the player.
- When transporting the player, the original shipping carton and packing materials come in handy. For maximum protection, repack the unit as it was originally packaged at the factory.
- Do not use volatile liquids, such as insect spray, near the player. Do not leave rubber or plastic products in contact with the player for a long time. They will leave marks on the finish.
- The player may become warm after a long period of use. This is not a malfunction.
- When the player is not in use, be sure to remove the disc and turn off the power.
- If you do not use the player for a long period, the unit may not function properly in the future. Turn on and use the player occasionally.

## Notes on locating

- When you place this player near a TV, radio, or VCR, the playback picture may become poor and the sound may be distorted. In this case, move the player away from the TV, radio, or VCR.

## Notes on cleaning

- Use a soft, dry cloth for cleaning.  
For stubborn dirt, soak the cloth in a weak detergent solution, wring well and wipe. Use a dry cloth to wipe it dry.  
Do not use any type of solvent, such as thinner and benzene, as they may damage the surface of the player.  
If you use a chemical saturated cloth to clean the unit, follow that product's instructions.
- When cleaning the LCD monitor, use a soft, dry cloth.

## To obtain a clear picture

The player is a high technology, precision device. If the optical pick-up lens and disc drive parts are dirty or worn down, the picture quality becomes poor. To obtain a clear picture, we recommend regular inspection and maintenance (cleaning or parts replacement) every 1,000 hours of use depending on the operating environment. For details, contact your nearest dealer.

## Notes on moisture condensation

**Moisture condensation damages the player. Please read the following carefully.**

Moisture condensation occurs, for example, when you pour a cold drink into a glass on a warm day. Drops of water form on the outside of the glass. In the same way, moisture may condense on the optical pick-up lens inside this unit, one of the most crucial internal parts of the player.

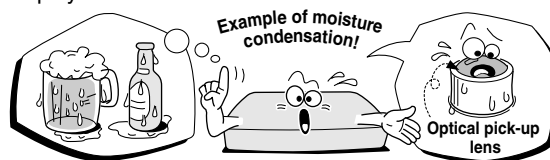

■ **Moisture condensation occurs during the following cases.**

- When you transport the player directly from a cold place to a warm place.
- When you use the player in a room where you just turned on the heater, or a place where the cold air from the air conditioner directly hits the unit.
- In summer, when you use the player in a hot and humid place just after you move the unit from an air conditioned room.
- When you use the player in a humid place.

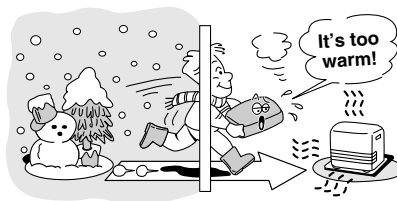

■ **Do not use the player when moisture condensation may occur.**

If you use the player in such a situation, it may damage discs and internal parts. Remove the disc, connect the AC adapter, turn on the player, and leave it for two or three hours. After two or three hours, the player will have warmed up and evaporated any moisture.



# Notes and Information

## Structure of disc contents

Normally, DVD video discs are divided into titles, and the titles are sub-divided into chapters. DVD audio discs are divided into groups, and the groups are sub-divided into tracks. VIDEO CDs/audio CDs are divided into tracks.

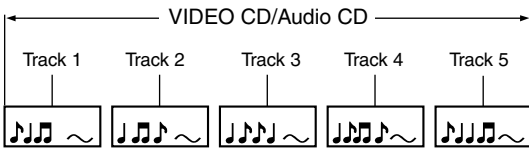
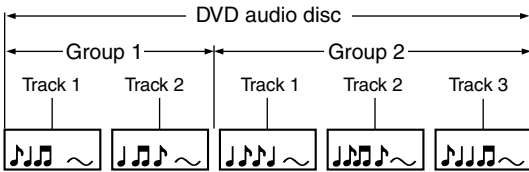
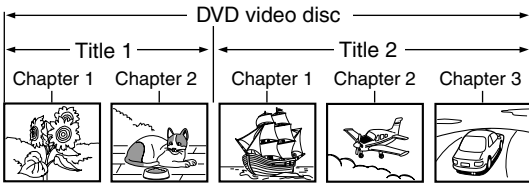

Each title, chapter, group, or track is assigned a number, which is called "title number", "chapter number", "group number" or "track number" respectively. There may be discs that do not have these numbers.

## On handling discs

- Do not touch the playback side of the disc.

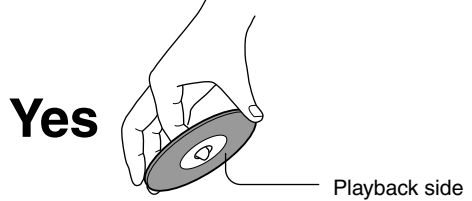

- Do not attach paper or tape to discs.



## On cleaning discs

- Fingerprints and dust on the disc may cause picture and sound deterioration. Wipe the disc from the center outwards with a soft cloth. Always keep the disc clean.



- If you cannot wipe off the dust with a soft cloth, wipe the disc lightly with a slightly moistened soft cloth and finish with a dry cloth.
- Do not use any type of solvent such as thinner, benzene, commercially available cleaners or antistatic spray for vinyl LPs. It may damage the disc.

## On storing discs

- Do not store discs in a place subject to direct sunlight or near heat sources.
- Do not store discs in places subject to moisture and dust such as a bathroom or near a humidifier.
- Store discs vertically in a case. Stacking or placing objects on discs outside of their case may cause warping.



## Notes on copyright

It is forbidden by law to copy, broadcast, show, broadcast on cable, play in public, and rent copyrighted material without permission.

DVD video discs are copy protected, and any recordings made from these discs will be distorted.

This product incorporates copyright protection technology that is protected by method claims of certain U.S. patents and other intellectual property rights owned by Macrovision Corporation and other rights owners. Use of this copyright protection technology must be authorized by Macrovision Corporation, and is intended for home and other limited viewing uses only unless otherwise authorized by Macrovision Corporation. Reverse engineering or disassembly is prohibited.



## Notes and Information (continued)

### About this owner's manual

This owner's manual explains the basic instructions of this player. Some DVD video discs are produced in a manner that allows specific or limited operation during playback. As such, the player may not respond to all operating commands. This is not a defect in the player. Refer to instruction notes of discs.

"Ⓞ" may appear on the screen during operation. A "Ⓞ" means that the operation is not permitted by the player or the disc.

### Notes on region numbers

The region number of this player is 1. Region numbers, corresponding to specific geographical playback area, are printed on your DVD video disc. If you do not find  or , disc playback will not be allowed by the player. (In this case, the player will display a message on-screen.)

### On VIDEO CDs

This player supports VIDEO CDs equipped with the PBC (Version 2.0) function. (PBC is an abbreviation for Playback Control.)

You can enjoy two playback variations depending on types of discs.

- VIDEO CD not equipped with PBC function (Version 1.1)  
Sound and movie can be played on this player in the same way as an audio CD.
- VIDEO CD equipped with PBC function (Version 2.0)  
In addition to operation of a VIDEO CD not equipped with the PBC function, you can enjoy playback of interactive software with search function by using the menu displayed on the screen (Menu Playback). Some functions described in this owner's manual may not work with all discs.

### Playable discs

This player can play the following discs.

	Disc Mark	Contents	Disc Size
DVD video discs		Video (moving pictures) + Audio	12 cm
			8 cm
DVD audio discs		Audio + Video	12 cm
			8 cm
VIDEO CDs		Video (moving pictures) + Audio	12 cm
			8 cm
Audio CDs		Audio	12 cm
			8 cm (CD single)
<p>The following discs are also available.</p> <ul style="list-style-type: none"> <li>● DVD-R discs of DVD video format</li> <li>● CD-R/CD-RW discs of CD-DA or VIDEO CD format</li> </ul> <p>Some of these discs may be incompatible.</p>			

- You cannot play discs other than those listed above.
- You cannot play discs of DVD-RAM or non-standardized discs, etc., even if they may be labeled as above.
- This player uses the NTSC color system.

Because of problems and errors that can occur during the creation of DVD software and/or the manufacture of DVD discs, Toshiba America Consumer Products, L.L.C. and Toshiba of Canada, Ltd. cannot guarantee that this player will play every feature of every DVD bearing the DVD logo. As one of the creators of DVD technology, Toshiba DVD players are manufactured to the highest standards of quality and, as a result, such incompatibilities are very rare. If you happen to experience and difficulty playing a DVD on a Toshiba DVD player, please feel free to call our Contact listed in "How to Obtain Service" .

## Playable memory cards

This player can play the following memory cards.

	Card Mark	Contents
SD Memory Card		Photograph (JPEG files)
Multi Media Card	MMC	

- SD™ is a trademark.

## Notes on memory cards

Memory cards available for this player are MMC and SD™ Memory Card.

Some memory cards may not be played back due to its capacity and/or manufacturer, etc.

Other memory cards are not supported. Do not insert any cards apart from MMC/SD™ Memory Card as this may cause a malfunction of the player or cards.

\* MMC is a MultiMediaCard.

### ■ Saving data

It is recommended that you copy and backup any and all important information to a disk (MO disk, floppy disk, hard disk, etc.)

Recorded data may be lost or damaged in the below cases. Toshiba Corporation accepts no responsibility whatsoever for lost or damaged data.

- You or a third party does not use the memory card correctly.
- The memory card incurs damage from static electricity or electrical interference.
- The memory card is ejected while in use.

### ■ Cautions for use

- Ensure that you insert the memory card correctly into this player.
- Do not eject the memory card while it is in use. If ejected while in use information on the memory card may be lost.
- This memory card is a precision electrical instrument. Do not bend, drop or apply strong force to it.
- Do not use or store the memory card in an environment of high static electricity or electrical interference.
- Avoid using or storing in areas of high temperature and humidity.
- Be careful not to touch with your fingers, nor allow foreign objects to come in contact with nor dirt to accumulate on the metal area (gold-colored area) of the memory card. Wipe off any dirt with a soft, dry cloth.
- When carrying or storing the memory card always place it inside of its antistatic case to avoid any effects from static electricity. If there is a storage case, place the memory card in the antistatic area of the storage case.
- If you place a memory card that has been exposed to static electricity in this player, there is a chance that this player could malfunction.
- Do not place the memory card in your pants pocket. The memory card may break if any strong force is applied, such as when sitting.
- When ejecting the memory card after extended use it may feel warm to the touch. This is normal. The memory card is not malfunctioning.
- The memory card is designed to have a long life but after extended use you will not be able to delete from or write to it. Please purchase another.

### ■ Write Protection of SD Memory Card

- Switch the write protect tab at the side of the SD card to "LOCK".

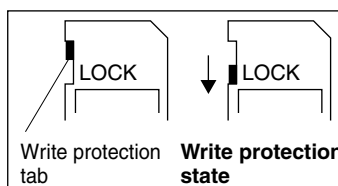

## **Notes and Information (continued)**

### **Exemptions**

- Toshiba Corporation is not liable for any damage caused by fire, natural disaster (such as thunder, earthquake), acts by a third parties, accidents, owner's intentional or unintentional misuse, or uses in other improper conditions.
- Toshiba Corporation is not liable for incidental damages (such as profit loss or interruption in business, etc.) caused by use or inability to use of this player.
- Toshiba Corporation is not liable for any damage caused by neglect of the instructions described in the owner's manual.
- Toshiba Corporation is not liable for any damage caused by misuse or malfunction through joint use of this player and connected equipment or software.

### **On disposal**

This product contains mercury. Disposal of this material may be regulated due to environmental considerations. For disposal or recycling information, please contact your local government or the Consumer Electronics Association.

# Table of Contents

## Introduction

- SAFETY PRECAUTIONS ..... 2
- IMPORTANT SAFETY INSTRUCTIONS ... 4
- Precautions ..... 7
- Notes and Information ..... 8
  - Notes on region numbers ..... 10
- Table of Contents ..... 13
- Identification of Controls ..... 14
  - Main unit ..... 14
  - Side view ..... 15
  - Rear view ..... 15
  - Remote control ..... 16
  - Loading a battery ..... 17
  - Operating with the remote control ..... 17
- Power Connection ..... 18

## Basic playback

- Playing a Disc ..... 20
  - Basic playback ..... 20
- Variable Speed Playback ..... 25
  - Playing in fast reverse or fast forward directions ... 25
  - Playing frame by frame ..... 25
  - Playing in slow-motion ..... 26
  - Resuming playback from the stopped location .. 26
- Locating a Specific Title, Chapter, or Track ..... 27
  - Locating a title using the top menu ..... 27
  - Locating a desired section by entering its corresponding number ..... 28
  - Locating a specific chapter or track ..... 29
- Playing MP3/WMA Files ..... 30
  - Playing MP3/WMA files ..... 30
- Viewing JPEG Files - Digital Photo Viewer - ..... 32
  - Viewing JPEG files ..... 33
  - Photo Album ..... 34
  - Photo View ..... 35
  - Slide Show ..... 38

## Advanced playback

- Accessing a Specific Location Directly .. 44
  - Entering the time counter of the desired location ... 44
- Zooming a Picture ..... 45
  - Zooming a picture ..... 45
- Selecting a Camera Angle ..... 46
  - Changing the camera angle ..... 46
- Selecting Subtitles ..... 47
  - Selecting a subtitle language ..... 47
- Selecting a Language ..... 48
  - Selecting a playback audio setting ..... 48

## Quick control

- Using the Virtual Remote Control - V-REMOTE - ..... 52
  - Using the virtual remote control ..... 52
- Selecting the Playback Function - QUICK - ..... 53
  - Selecting the playback function ..... 53
  - Playing in the selected mode ..... 54
- Accessing Features - NAVI - ..... 58
  - NAVI menu items ..... 58

## Function setup

- Customizing the Function Settings ..... 66
  - Setting procedure ..... 66
  - Setting details ..... 68
- Table of Languages ..... 75
  - Table of languages and their abbreviations ... 75

## Connections

- Connecting to a TV ..... 78
- Connecting to Headphones ..... 80
- Viewing Pictures from Connected Video Equipment ..... 80
- Connecting to Audio Equipment ..... 81
  - Connecting to an amplifier equipped with a Dolby Digital decoder ..... 82
  - Connecting to an amplifier equipped with Dolby Surround Pro Logic ..... 82
  - Connecting to an amplifier equipped with a DTS decoder ..... 83
  - Connecting to an amplifier equipped with an MPEG2 audio decoder ..... 83
  - Connecting to an amplifier equipped with a digital audio input ..... 84
- Using the Battery Pack ..... 85
- Using the automobile/vehicle adapter or power port ..... 87

## Others

- Before Calling Service Personnel ..... 90
- Specifications ..... 91
- LIMITED WARRANTY PORTABLE DVD PLAYER ..... 92

# Identification of Controls

See the page in    for details.

## Main unit

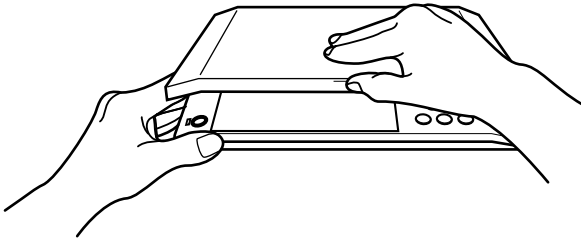

While holding the player base, push the top of the LCD screen unit and lift up to open.

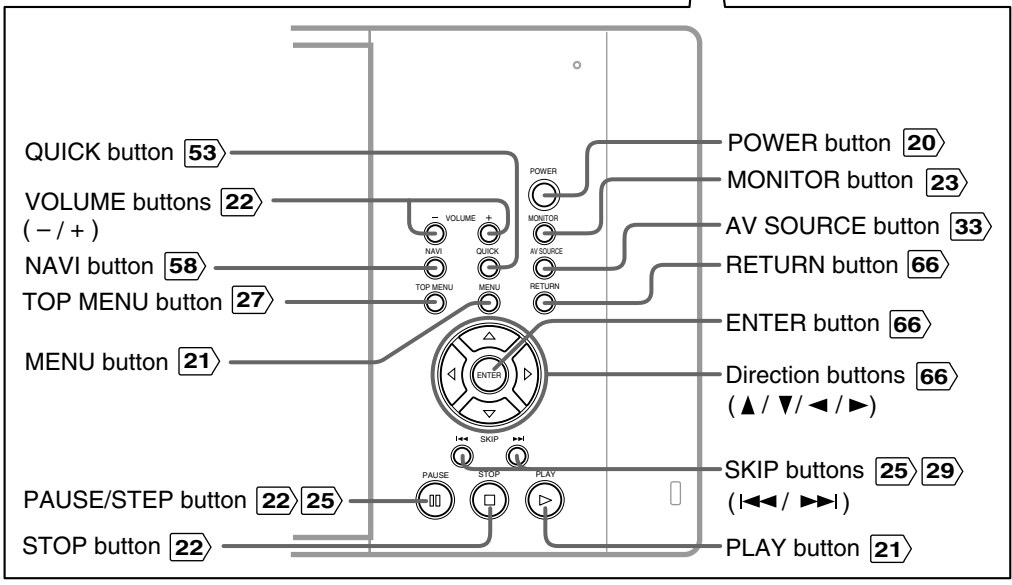
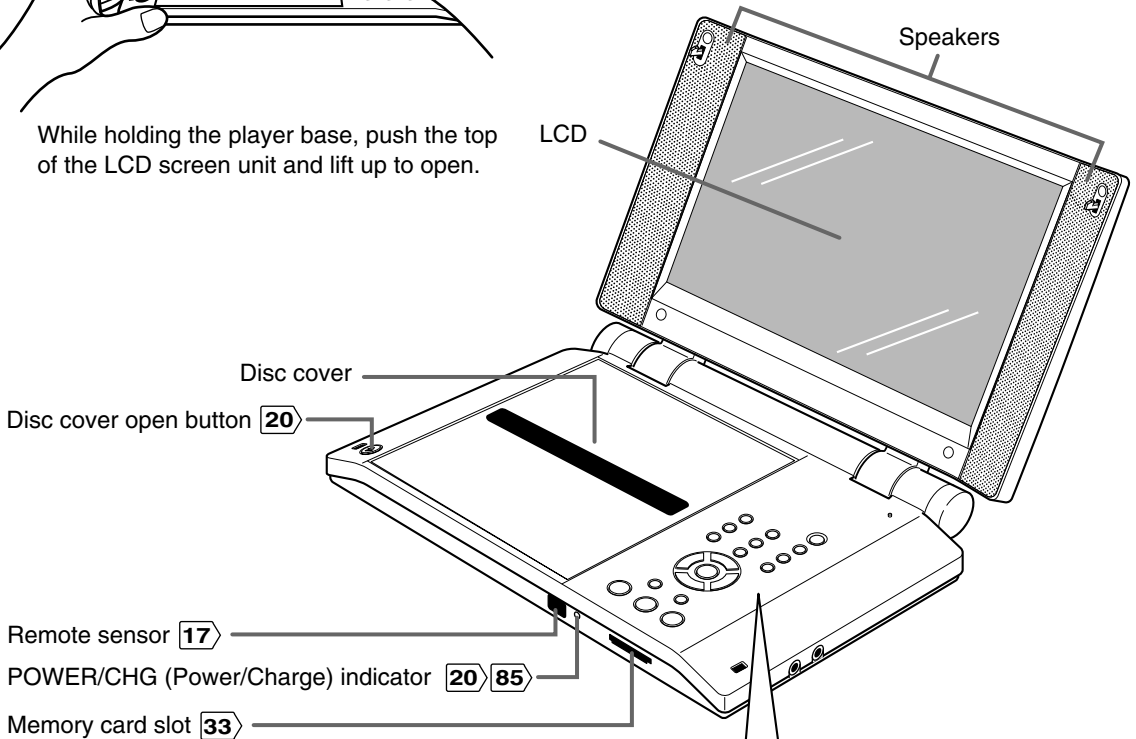

Side view

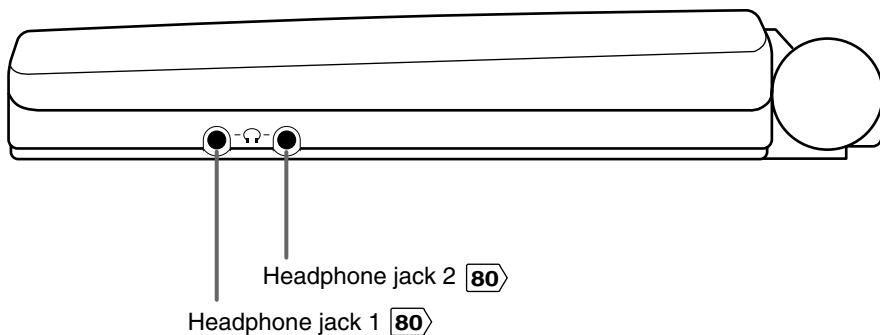

Rear view

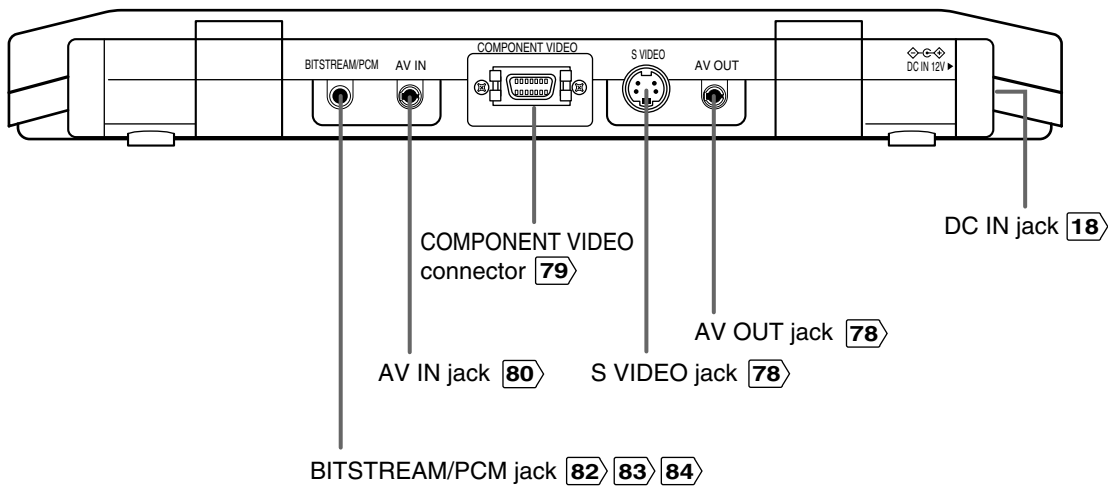

# Identification of Controls (continued)

The instructions in this manual describe the functions of the remote control. See the page in   for details.

## Remote control

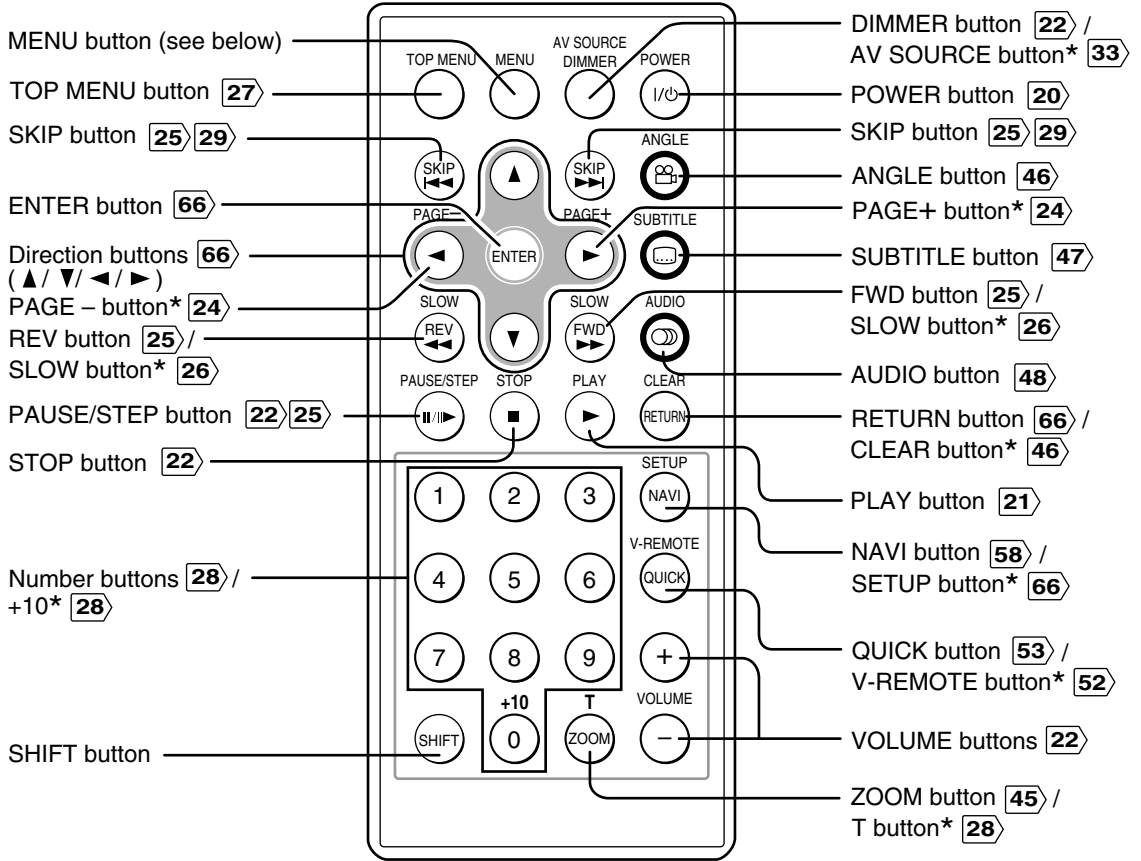

**" \* " buttons**

Operate these buttons while simultaneously pressing the SHIFT button.

**MENU button**

Use the MENU button to display the menu included on many DVD video discs. To operate a menu, follow the instructions in "Locating a title using the top menu." **27**



## Loading a battery

- 1** While pushing the holder in direction ①, simultaneously slide it out in direction ②.

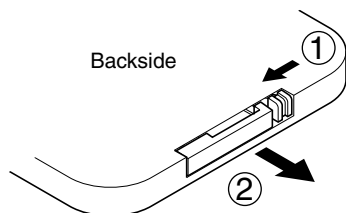

- 2** Place a coin-shaped battery (CR2025) with the  $\oplus$  side up on the holder.

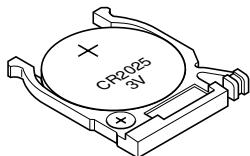

Keep the holder horizontal so that the battery does not fall through.

- 3** Push the holder back into its receptacle.

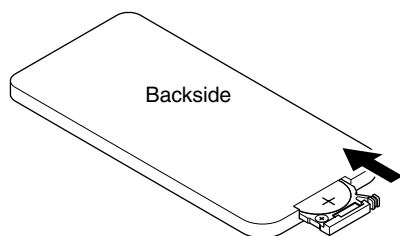

### Notes on coin-shaped batteries

- If the remote control does not function correctly or if the operating range becomes reduced, replace the battery with new one.
- See **6** for safety use of coin-shaped batteries.
- Inserting a battery other than the specified one or an object may damage the remote control.

## Operating with the remote control

- Point the remote control at the remote sensor and press the buttons.

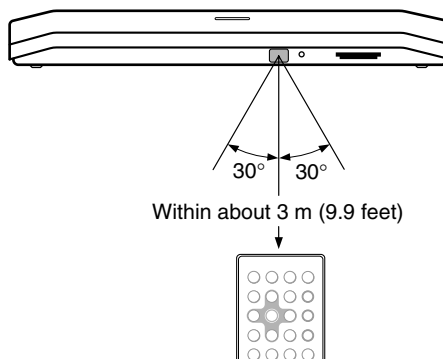

Distance: About 3 m (9.9 feet) from the front of the remote sensor

Angle: About 30° in each direction of the front of the remote sensor

- \* Do not expose the remote sensor of the player to a strong light source such as direct sunlight or other illumination. If you do so, you may not be able to operate the player via the remote control.

### Notes on the remote control

- Direct the remote control at the remote sensor of the player.
- Do not drop or give the remote control a shock.
- Do not leave the remote control near an extremely hot or humid place.
- Do not spill water or put anything wet on the remote control.
- Do not disassemble the remote control.

# Power Connection

Connect the supplied AC adapter to power the player.  
For outdoor use, the battery pack (supplied) is also available.  
When using the battery pack, follow the instructions on page 85.

**Caution**

- Do not connect the power plug to a power outlet other than that indicated on the label, as this can result in a risk of fire or electric shock.
- Do not connect or disconnect the power plug with wet hands. Doing so may cause electric shock.
- Do not use an AC adapter other than one specified, as it can cause a fire or damage to the player.
- When the AC adapter is in use, its temperature may increase. However, it is not a malfunction. Make sure that the power cord is disconnected and the temperature decreases before carrying it.

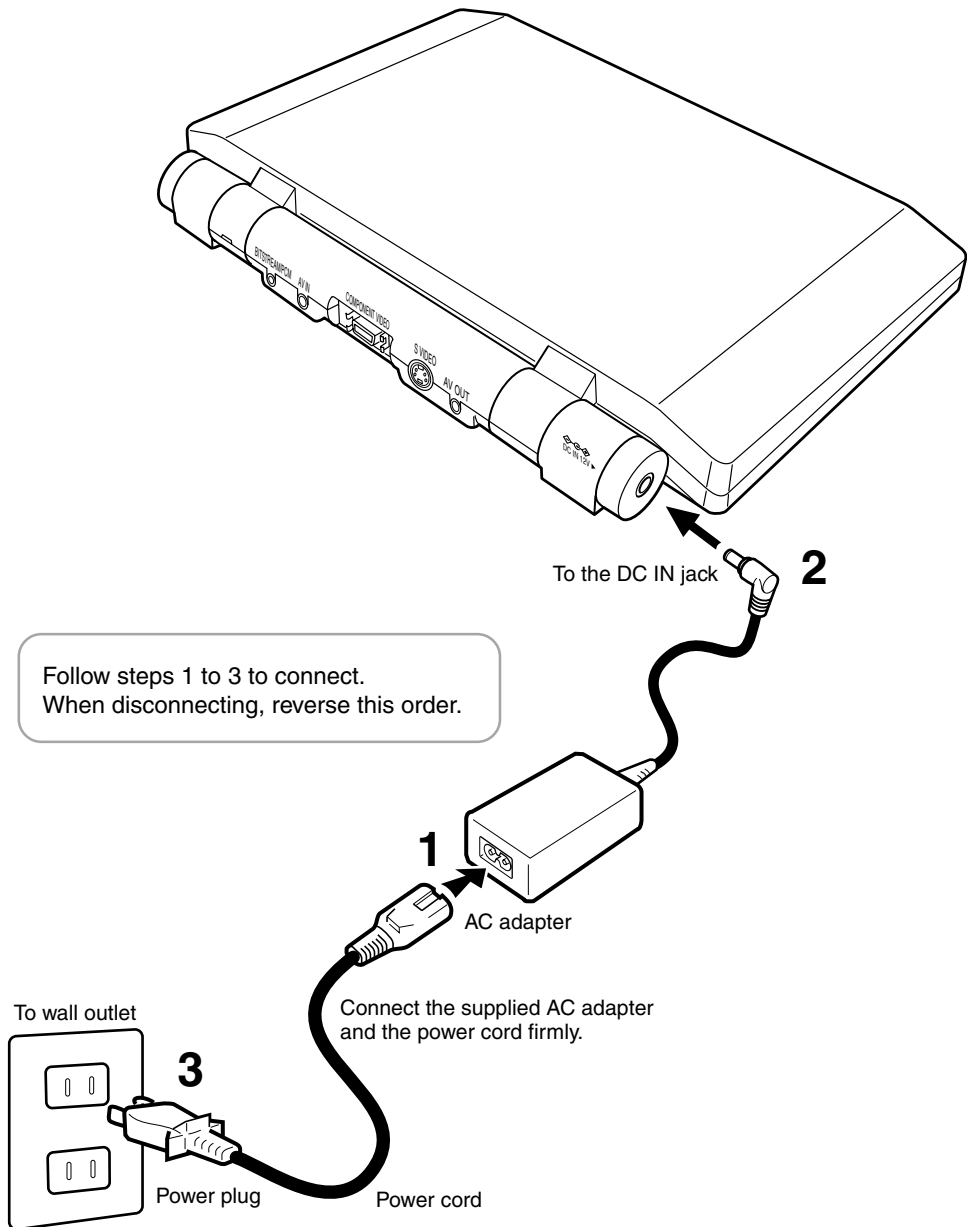

# Basic playback

Begin your operation.



- **Playing a Disc**
- **Variable Speed Playback**
- **Locating a Specific Title, Chapter, or Track**
- **Playing MP3/WMA Files**
- **Viewing JPEG Files**  
- Digital Photo Viewer -

## **About this manual**

- The numbers indicated by lines on the illustrations correspond to the associated steps of the operation.
- Aside from the section "Playing a Disc", explanations of operations only include illustrations of the corresponding buttons on the remote control. The buttons sharing the same name on the main unit can also be used in the identical manner.

# Playing a Disc

This section shows you the basics on how to play a disc.

 indicates a reference page of this manual.  
See the page in  for details.





### CAUTION

- Keep your fingers clear of the disc as it is spinning. Neglecting to may cause serious personal injury.
- Be careful not to catch your fingers in the disc holder.
- Do not use a cracked, deformed, or repaired disc.
- Do not tilt, shake or move the main unit while playing. It may damage the disc.



## Basic playback

### Preparations

- Connect the AC adapter  or the battery pack  to the player.
- When you want to view a disc on a connected TV or monitor, turn on the equipment and select the video input connected to the player.
- When you want to enjoy the sound of discs from an audio system, turn the audio system on and select the input connected to the player.
- If you use the supplied remote control, make sure that batteries are loaded in it. 
- If you use the headphones, see “Connecting to Headphones”. 

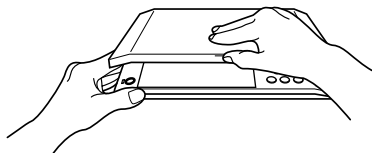

While holding the player base, push the top of the LCD screen unit and lift up to open.

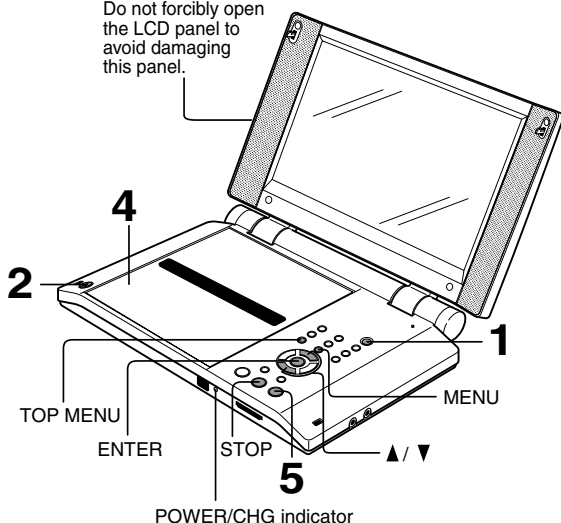

Do not forcibly open the LCD panel to avoid damaging this panel.

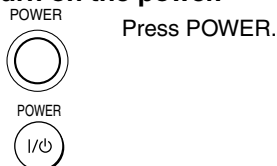

### 1 Turn on the power.



Press POWER.  
The player turns on and the POWER/CHG indicator on the player illuminates in green.

When the player is turned on for the first time, an on-screen display will appear to provide initial setup. Move the cursor control () to select an item, and press the ENTER button. See the pages in , and make a selection moving the cursor control (), then press the ENTER button.

On-Screen Language   
TV Shape 

After making all the settings, select “” and press the ENTER button.

### 2 Open the disc cover.

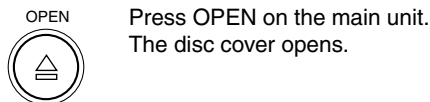

Press OPEN on the main unit.  
The disc cover opens.  
The cover is designed to stop at 2 positions. Do not force the cover open further, as it may cause damage to the player.

### 3 Set a disc.

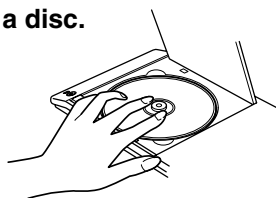

Place a disc with the playback side down, and push gently on the center of the disc to affix it to the spindle.

### 4 Close the disc cover.

Press CLOSE on the left corner.

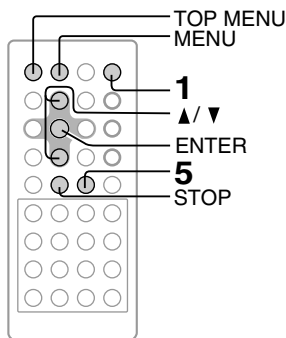

■ To obtain a higher quality picture

Occasionally, some picture noise not usually visible during a normal broadcast may appear on the TV screen while playing a DVD video disc because the high resolution pictures on these discs include a lot of information. While the amount of noise depends on the TV you use with this player, you should generally reduce the sharpness adjustment on your TV when viewing DVD video discs.

■ About DVD-V DVD-A VCD CD

The DVD-V DVD-A VCD CD icons on the heading bar show the playable discs relevant to the function described under each heading.

- DVD-V : DVD video discs.
- DVD-A : DVD audio discs.
- VCD : VIDEO CDs.
- CD : Audio CDs.

5 Start playback.

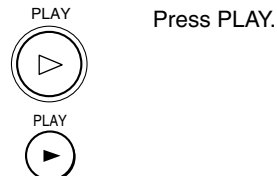

**DVD-V** If you select a DVD video disc that contains a top menu, or select a PBC (Playback Control)-featured VIDEO CD (10), a menu may appear. See "Locating a title using the top menu". 27

- You may need to press the TOP MENU or MENU button to display disc menu (depending on the actual DVD video disc.)

**DVD-A** A menu may appear depending on the disc. See "Locating a title using the top menu" 27.

■ To start playback in the stop mode.

Press **PLAY**.



Notes

- Do not put an unplayable disc or any objects other than discs in the disc holder.
- In many instances, a menu screen will appear after playback of a movie is completed. Prolonged display of an on-screen menu may damage your television set, permanently etching that image onto its screen. To avoid this, be sure to press the STOP button once the movie is completed.

CAUTION

Never operate the player in a moving vehicle. Vibration may prevent proper playback of the player or cause damage to the disc.

# Playing a Disc (continued)

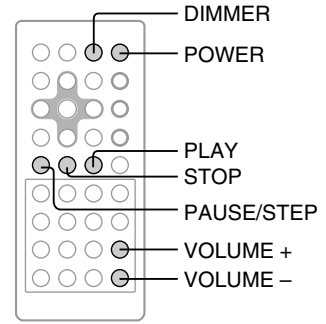

## Basic playback (continued)

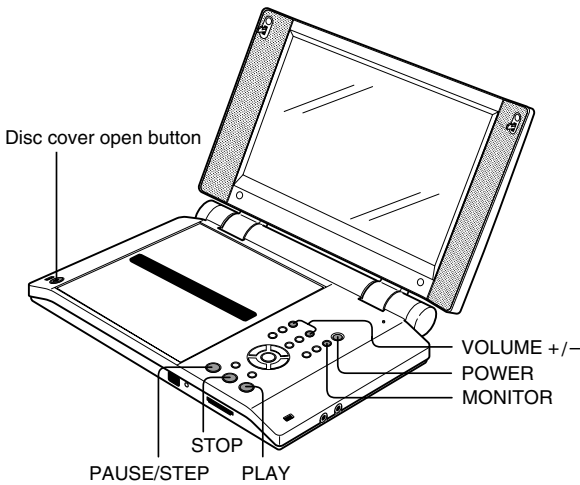

### To change LCD brightness

Press **DIMMER** on the remote control.



4 pre-selected brightness levels are provided.

### Note

Only 2 brightness levels are available when using the battery pack.

### To adjust the volume of the speakers or the connected headphones

Press **VOLUME +** or **VOLUME -**.

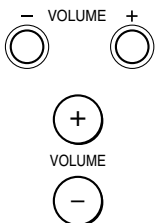

### To pause playback (still mode)

Press **PAUSE/STEP** during playback.



To resume normal playback, press **PLAY**.

- Sound is muted during still mode.



### To stop playback

Press **STOP**.



### To turn off the power

Press **POWER**.



### To remove the disc

Press the disc cover open button on the main unit to open the disc cover.



Remove the disc from under the rim while gently pressing down on its center.

Close the disc cover after removing the disc.

### CAUTION

Do not touch the spindle immediately after prolonged play, as it may have become hot. Be careful in loading/removing a disc.

### ■ LCD screen/external screen selection

Press **MONITOR** button on the player.



Each time the button is pressed, the LCD screen will change as below.

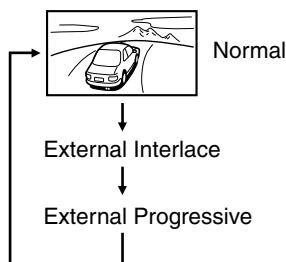

External Interface: When connected to an Interlaced TV or monitor.

External Progressive: When connected to a Progressively scanned TV or monitor.

#### Notes

- After selecting the external screen, images will be displayed on the LCD monitor for 3 seconds before switched to the external screen mode.
- Normal images will not appear if the output signal is set to Progressive and connected to an Interlace compatible TV. Select the proper output signal settings via the LCD monitor of this device.
- The MONITOR button can not work while you are viewing an input source from the connected equipment.

### ■ About the screen saver

If you pause a picture of a DVD video disc and leave it still for a long while, the screen saver of the player automatically appears (when “Screen Saver” is set to “On” **[72]**). To turn off the screen saver, press the **PLAY** button on the main unit or remote control.

### ■ Automatic Power Off function

If the player is stopped, or the screen saver is engaged for approximately 20 minutes, the player will automatically turn itself off.

### ■ About the LCD

- The color LCD is manufactured using extremely high precision technology, but even so may include certain pixels that do not operate properly (that do not light, that remain lit constantly, etc.). We do our best to keep the number of these defective pixels to a minimum, but please understand that they cannot be completely eliminated even with the most advanced manufacturing technologies available today.
- The fluorescent tube which illuminates the panel from the inside will deteriorate with use. (The standard life length is about 10,000 hours of continuous use at normal temperature. This is referential information only and is not warranted.) When the LCD becomes dim, flickers, or does not illuminate, contact your dealer for replacement.
- The brightness of the LCD monitor differs slightly depending on the viewing angles. Adjust the LCD monitor angle to obtain the best viewing. (The recommended viewing angle is 90 degrees to the monitor.)

# Playing a Disc (continued)

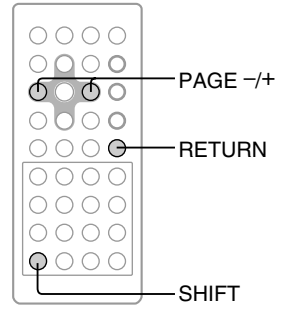



## Basic playback (continued)

### ■ Still pictures included on DVD audio discs

DVD audio discs may include still pictures, which are classified into two large groups.

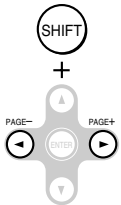
- Slideshow: Still pictures appear one after another automatically consistent with the disc program. Their order, or viewing time cannot be modified.
- Browsable pictures: You can display your favorite still picture selected via the remote control. Some of those may change automatically.

 : Press **PAGE** while pressing **SHIFT** to select a picture. (The order of pictures vary depending on the disc)

 : To return to a specific picture programmed on the disc.



## Variable Speed Playback

You can play discs at various speeds, and resume playback from the location where you stopped playback.

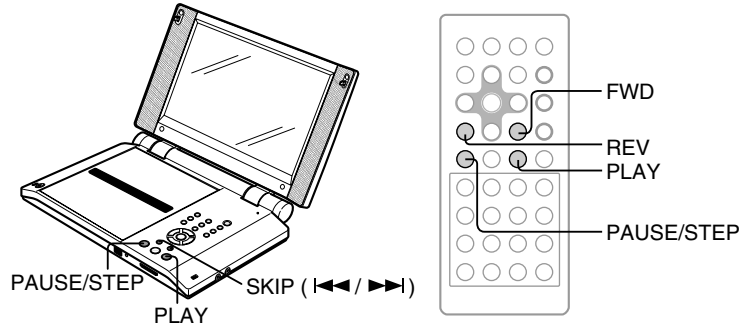

DVD-V DVD-A  
VCD CD

### Playing in fast reverse or fast forward directions

Press REV or FWD on the remote control during playback.



REV: Fast reverse playback  
FWD: Fast forward playback



Each time you press the REV or FWD button, the playback speed changes.

Press and hold SKIP (I<<</>>>I) on the main unit during playback.



SKIP



Fast forward playback

Fast reverse playback

During the fast forward or fast reverse playback, you can vary the speed by pressing the button repeatedly.

■ To resume normal playback

Press PLAY.

PLAY



**Notes**

- The player mutes sound and omits subtitles during reverse and forward scan of DVD video discs.
- DVD audio discs may not be played in fast reverse or fast forward directions.
- The playback speed may differ depending on the disc.

DVD-V DVD-A  
VCD CD

### Playing frame by frame

Press PAUSE/STEP during still playback.

PAUSE/STEP



Each time you press the PAUSE/STEP button, the picture advances one frame.

■ To resume normal playback

Press PLAY.

PLAY



**Notes**

- The sound is muted during frame by frame playback.
- When using a DVD audio disc that includes pictures, this operation may be permitted in some picture segments.

# Variable Speed Playback (continued)

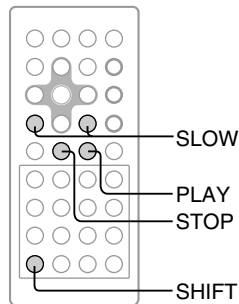

## DVD-V DVD-A VCD CD Playing in slow-motion

**Press SLOW while pressing SHIFT during playback.**

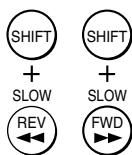

Each time you press the SLOW ►► button, the slow-motion speed changes.

If you press the SLOW ◄◄ button during playback, you can view the picture in reverse slow-motion. (Only when using a DVD video disc.)

Each time you press the SLOW ◄◄ button, the slow-motion speed changes.

### ■ To resume normal playback

Press **PLAY**.



### Notes

- The sound is muted during slow-motion playback.
- The playback speed may differ depending on the disc.
- When using a DVD audio disc that includes pictures, this operation may be permitted in some picture segments.

## DVD-V DVD-A VCD CD Resuming playback from the stopped location

**1 Press STOP at the location where you want to interrupt playback.**



The player memorizes the location where playback is stopped.

**2 Press PLAY.**



The player resumes playback from the location where you stopped playback.

2 Press **PLAY**.



- DVD-V** Playback starts from the beginning of the current title.
- DVD-A** Playback starts from the beginning of the current group.
- VCD** Playback starts from the beginning of the disc.
- CD** Playback starts from the beginning of the disc.

- If you want to return to the beginning of a DVD video/ audio disc, turn the power off and on by pressing the **POWER** button, and then start playback.

### Notes

- The player's memory is also cleared when:
  - you change the parental lock setting [72] or select a disc menu language [70].
  - you use a PBC-featured VIDEO CD while "PBC" is set to "On" [74].
- There may be a difference in the location where playback resumes depending on the disc. Especially when using a DVD audio disc, playback may resume from the beginning of the current track.
- Settings you changed using the on-screen displays while the player stores a location in its memory may function only after the memory is cleared.

### ■ To start playback from the beginning regardless of the location where you stopped playback

1 Press **STOP** twice.



The player's memory is cleared.

# Locating a Specific Title, Chapter, or Track

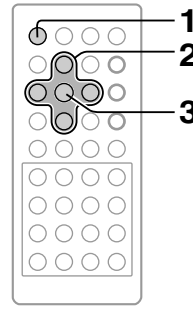

Normally, DVD video discs are divided into titles, and the titles are sub-divided into chapters. Contents of DVD audio discs are divided into groups, and the groups are sub-divided into tracks. VIDEO CDs and audio CDs are divided into tracks. You can quickly locate any specific title, chapter, group, or track.

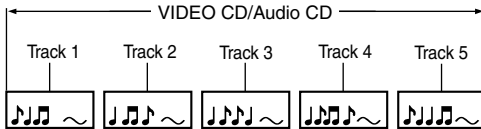
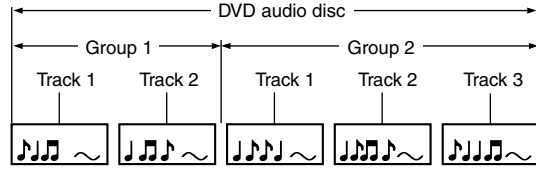
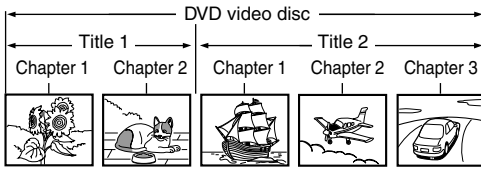

## DVD-V DVD-A VCD CD Locating a title using the top menu

### 1 Press TOP MENU.



The top menu appears.

e.g.

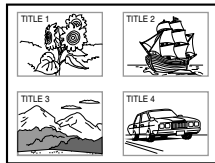

### 2 Press ▲/▼/◀/▶ to select the title you want.



If the titles in the top menu are assigned a number, you can directly locate a specific title by pressing its designated number with the number buttons.

### 3 Press ENTER.



Playback starts from chapter 1 of the selected title.

#### Notes

- The instructions above describe basic procedures which may vary depending on the contents of the DVD video disc. If different instructions appear on the screen, follow those instructions.
- If you display the top menu during playback and press the TOP MENU button again without selecting any title, the player may resume playback from the point where you first pressed the TOP MENU button (depending on the actual DVD video disc.)  
When using a DVD audio disc, the player resumes playback from the beginning of the track where you pressed the TOP MENU button.
- This method of locating a title is available only on a disc that contains a top menu.
- Instruction notes of discs may refer to the button that displays the top menu as TITLE button.

# Locating a Specific Title, Chapter, or Track (continued)

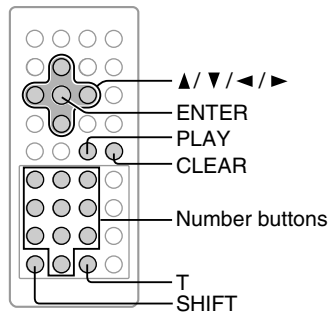

**DVD-V DVD-A VCD CD** **Locating a desired section by entering its corresponding number**

### 1 Press T while pressing SHIFT.

If you are using a VIDEO CD/audio CD, skip steps 1 and 2. Then at step 3, enter the number for the track you want using the number buttons.

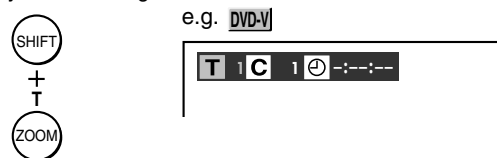

### 2 Press ◀/▶ to select a section you want to locate.

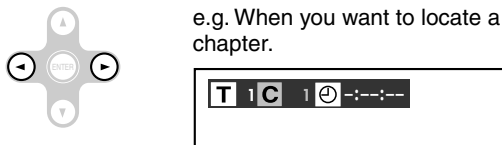

### 3 Press ▲/▼ to enter a number of the section.

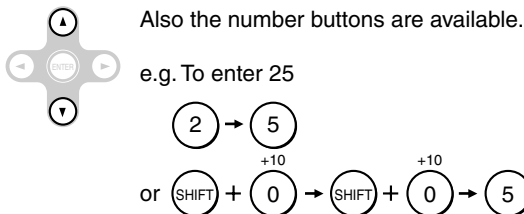

### 4 Repeat steps 2 and 3 if necessary.

### 5 Press PLAY or ENTER.

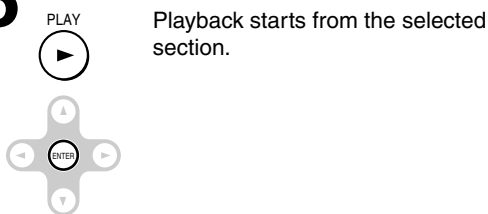

**Notes**

- Pressing the CLEAR button while pressing SHIFT button resets the numbers. To clear the display, press the T button while pressing SHIFT button several times.
- This method of locating a title/group is available only on a disc that contains title/group numbers.

■ **Playing bonus groups of DVD audio discs**

Some DVD audio discs may include an extra content called "Bonus group". If you select it to play, a display appears to enter a key number. Press the **number buttons** to enter the key number, then press **ENTER**. When the number is entered correctly, playback of the bonus group starts. To get key numbers, refer to instruction notes of discs.

**Notes**

- A key number may be cleared in some cases such as when removing the disc. Enter the key number again if necessary.
- When you use a bonus group in a programmed play such as memory playback, enter the key number beforehand.

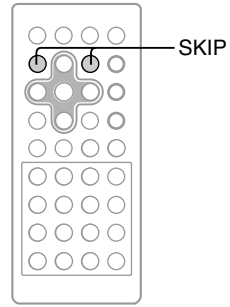

DVD-V | DVD-A  
VCD | CD

## Locating a specific chapter or track

### Press SKIP (⏮/⏭) repeatedly to display the chapter or track number you want.

Playback starts from the selected chapter or track.



To locate succeeding chapters or tracks.



Playback starts from the beginning of the current chapter or track.  
When you press twice, playback starts from the beginning of the preceding chapter or track.

#### Notes

- Some titles may not display chapter numbers.
- When you set “Title/Group Stop” to “Off” [74], you can access chapters in another title. If you go back to the preceding title by pressing the SKIP ⏮ button, the player locates the first chapter of the title. When “Title/Group Stop” is set to “On”, you can access chapters only within the current title.

## Playing MP3/WMA Files

You can play MP3/WMA files on this player.

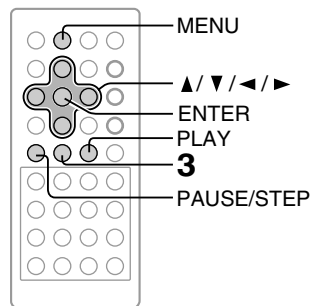

### Playing MP3/WMA files

#### Preparation

- Make sure that a disc you want to play is compatible with this player. [31](#)
- Set "Priority Contents 2" to "Audio" from the on-screen display. [74](#)

**1 Place a CD that contains MP3/WMA files on the disc holder and close the disc cover.**

**2 Press PLAY.**



Playback starts.

**3 To stop playback, press STOP.**



#### ■ To pause playback

Press **PAUSE/STEP** during playback.

PAUSE/STEP



To resume normal playback, press the **PLAY** button.

#### ■ Selecting a track (file name) in the disc

- 1 Press the **MENU** button.  
A list of file names appears.  
The current file name being played is highlighted in green.
- 2 Press the **▲/▼/◀/▶** buttons to select a file name you want to play.  
The selected file name is highlighted in blue.
- 3 Press the **ENTER** button to begin playback of the selected file name.

#### Notes

- Some discs may not permit this operation.
- WMA tracks copy-protected cannot be played.
- The BITSTREAM/PCM jack outputs MP3/WMA sounds in the linear PCM format regardless of the current "Audio Out Select" selection. [69](#)
- If you stop playback by pressing the STOP button, and then press the PLAY button, playback will start from the beginning of the track.
- The SKIP [29](#), REPEAT [55](#) and RANDOM [56](#) functions are also available.

## ■ Playable files

MP3/WMA disc compatibility with this player is limited as follows:

- Playable discs: CD-ROM, CD-R, CD-RW
- Sampling Frequency: 44.1 kHz only
- Bit rate: WMA: 48 kbps - 192 kbps(CBR)  
MP3: 32 kbps - 320 kbps (CBR)
- CD physical format: Mode 1, Mode 2 XA Form 1
- File system: ISO9660 Level 1, 2 or Joliet
- File name: File names are limited to eight characters or less and must incorporate "MP3" or "WMA" extension.  
e.g. "\*\*\*\*\*.MP3", "\*\*\*\*\*.WMA"  
File names cannot contain special characters such as "?!><+\*}{ [ @];\ / , " etc.
- Total number of files: Less than 255
- WMA codec version: V7 or V8 (Stereo sound only)

This player requires discs/recordings to meet certain technical standards in order to achieve optimal playback quality. Pre-recorded DVDs are automatically set to these standards. There are many different types of recordable disc formats (including CD-R containing MP3/WMA files). Given the fact that technology in this area is still maturing, Toshiba cannot guarantee that all genre of recordable discs will produce optimal playback quality. The technical criteria set out in this owner's manual are meant as a guide only.

Customers should also note that permission is required in order to download MP3 files and music from the internet. Toshiba has no right to grant such permission. Permission should always be sought from the copyright owner.

Microsoft, Windows Media, and the Windows Logo are trademarks or registered trademarks of Microsoft Corporation in both the United States and other countries.





## Viewing JPEG Files - Digital Photo Viewer -

A CD or memory card containing JPEG pictures can be played on this player.

Digital Photo Viewer allows you to view digital photographs and to quickly manipulate them with a few simple clicks of the remote. You can zoom, rotate, and pan.

This player can play the digital photo discs or memory cards that contains photographs (JPEG files\*).

\* For details, see [40](#).

You can enjoy viewing pictures in a variety of ways as follows.

### Photo Album

You can view a page consisting of up to 8 thumbnail images.

### Photo Album

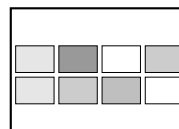

### Photo View

You can select a specific photograph from the Photo Album to view as a full-screen image.

Additionally, each image in this mode may be adjusted in the following ways:

Rotating in 90-degree increments.

Magnifying via 3 pre-defined settings

Shifting in 4 directions.

All 3 functions can be performed in conjunction with the other.

### Photo View

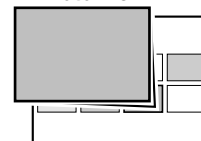

### Slide Show

You can view an automated slide show for a single roll or all rolls. The viewing times and order can be customized.

### Slide Show



### Preparation

- Set "Priority Contents 2" to "Photo" from the on-screen display. [74](#)
- Ensure that your player is properly set-up, and that you are familiar with the various remote control buttons and on-screen menus.
- Prepare a CD or memory card that contains JPEG files you want to view. [40](#)
- Make your TV shape conform to the 4:3 picture size. Only 4:3 pictures can be played regardless of the function settings via the on-screen displays of the player. If the TV is adjusted to other sizes, e.g. "WIDE", images will appear to be horizontally compressed. For details, refer to the owner's manual of your TV.



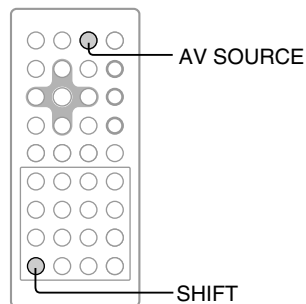

## Viewing JPEG files

- 1 Insert a CD or memory card that contains JPEG files into the player.

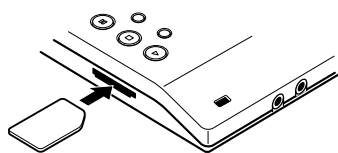

With a CD, close the disc cover.  
For a memory card, press the AV SOURCE button while pressing SHIFT to switch to the CARD mode.



Each time the button is pressed, the mode will alternate as below.

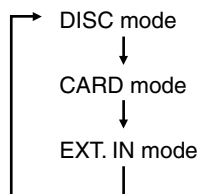

EXT. IN mode: External AV input mode.

The player activates the Digital Photo Viewer and displays the CD or memory card will appear in thumbnail display ("Photo Album").

e.g.

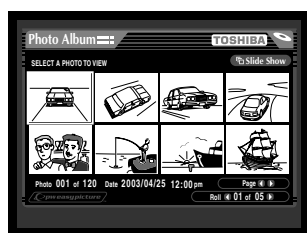

- 2 See [34] to [39] to select the viewing options.

### ■ Eject the memory card.

Confirm the memory card is not in use now.  
Lightly push in the memory card and then release.  
The memory card will partially eject. Pull the memory card out slowly and straight.  
To play a disc other than a CD that contains JPEG files, switch it to the DISC mode by pressing the AV SOURCE button while pressing SHIFT.

### Notes

- If a digital image does not contain a thumbnail version for display in the Photo Album, "Thumbnail Not Available" appears.
- Do not eject the memory card while it is in use. If ejected while in use, information on the memory card may be lost.
- To view JPEG files contained in a memory card, the files must be of DCF format.
- When connected to an external output, EXT.IN mode cannot be selected.
- Be sure to stop playing the disc before changing the mode.

# Viewing JPEG Files - Digital Photo Viewer - (continued)

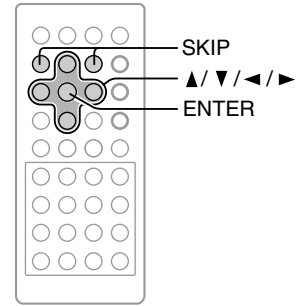

## Photo Album

You can view a page of up to 8 thumbnail images. On this mode, you can select a specific photograph to view as a full-screen image.

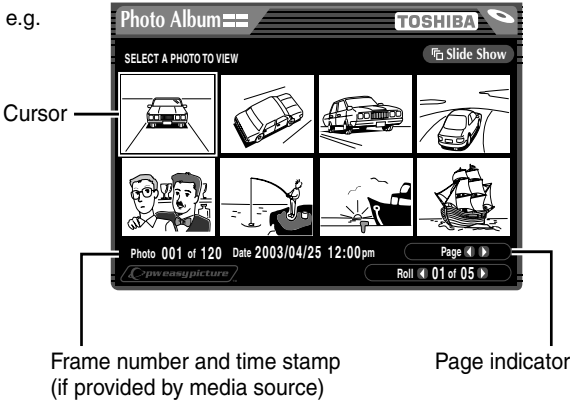

### Locating the next/previous roll (group)

Press ▲/▼/◀/▶ to select “Roll ◀\_of\_ ▶” then press ▶.

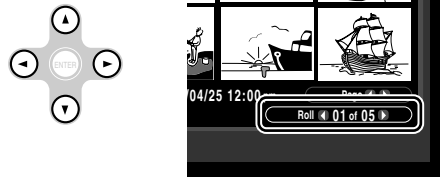

Pressing ◀ works in the reverse direction.

### Notes

- If you leave a Photo Album mode unattended for approximately 20 minutes, a slide show starts automatically. For details on the slide show, see “Slide Show” [38].
- The total number of rolls (groups) must be less than 100.

### Changing pages

Press SKIP ▶▶.



Pressing SKIP ◀◀ works in the reverse direction.

Alternatively,

Press ▲/▼/◀/▶ to select “Page ◀/▶” then press ▶.

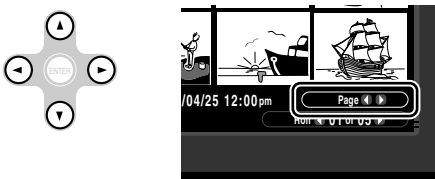

Pressing ◀ works in the reverse direction.

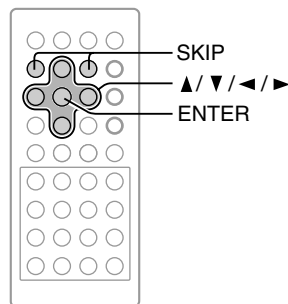

## Photo View

You can select a specific photograph from the Photo Album to view as a full-screen image.

Each image can be adjusted as follows:

- Rotating image by 90-degree at a time.
- Magnifying via 3 pre-defined settings.
- Shifting image in 4 directions.

All 3 functions can be performed simultaneously - e.g. an image may be rotated and zoomed in.

### Note

Customized settings are temporary and are not saved. These settings are automatically deleted after exiting Digital Photo Viewer playback.

**During a “Photo Album” display, press ▲/▼/◀/▶ to select a photograph to view full-screen, then press ENTER.**

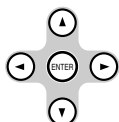

The selected photograph is displayed full-screen.

e.g.

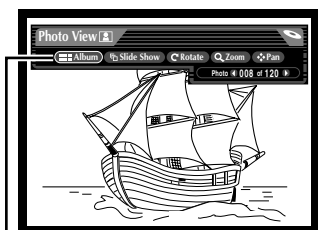

View adjustment buttons  
(Displayed for about 5 seconds.  
Pressing CLEAR can turn this off.)

### ■ To change photos

Press **SKIP** ►► or **ENTER** to view the next photo.



Pressing ◀◀ works in the reverse direction.



Alternatively,

- 1 If the view adjustment buttons are not displayed, press ▲/▼/◀/▶ to display them.
- 2 Press ◀/▶ to select “Photo ◀\_\_of\_\_▶” then press ►.



Pressing ◀ works in the reverse direction.

# Viewing JPEG Files - Digital Photo Viewer - (continued)

## Photo View (continued)

### ■ To adjust photo view

#### Rotating

Press **ANGLE** repeatedly.



The photograph rotates by clockwise 90-degree.

Alternatively,

- 1 If the view adjustment buttons are not displayed, press ▲/▼/◀/▶ to display them.
- 2 Press ◀/▶ to select "Rotate" then press **ENTER** repeatedly.

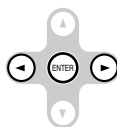

#### Note

Exiting the Digital Photo Viewer restores a rotated picture to its original posture.

#### Magnifying

Press **ZOOM** repeatedly.



The photograph view changes cyclically between the 3 magnification levels and the original size.

Alternatively,

- 1 If the view adjustment buttons are not displayed, press ▲/▼/◀/▶ to display them.
- 2 Press ◀/▶ to select "Zoom" then press **ENTER** repeatedly.

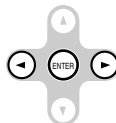

#### Note

Changing pictures restores a magnified picture to its original size.

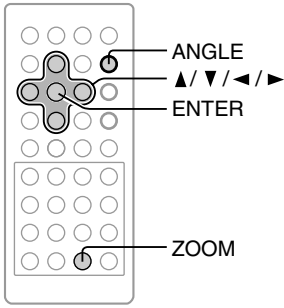

### Shifting

- 1 If the view adjustment buttons are not displayed, press ▲/▼/◀/▶ to display them.
- 2 Press ◀/▶ to select "Pan" then press **ENTER**.



The "Pan" button turns orange.

- 3 Press ▲/▼/◀/▶ to shift the photograph in the desired direction.



To exit "Pan" setting mode, press ENTER again to turn it white, then select the desired function by pressing ◀/▶.

### Note

Changing pictures restores a shifted picture to its original position.

### Notes

- All 3 functions can be performed together.
- These photo adjustments are temporary and are not saved. These are automatically deleted after exiting Digital Photo Viewer playback.

# Viewing JPEG Files - Digital Photo Viewer - (continued)

## Slide Show

You can view an automated slide show for a single roll or all rolls. The viewing times and order can be customized.

During a “Photo Album” or “Photo View” display, press ▲/▼/◀/▶ to select “Slide Show” then press ENTER.

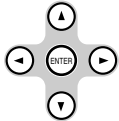

The first photograph of the arranged selection\* is displayed, and after a predetermined time the following ones appear in succession.

\*By “Set Order” setting. See “To customize Slide Show”.

e.g.

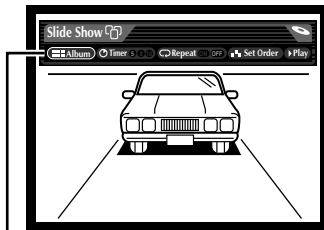

Slide Show customization buttons

### To stop the slide show on an image

Press PAUSE/STEP.

PAUSE/STEP



To resume, press PLAY.

### To customize Slide Show

- 1 Press ▲/▼/◀/▶ to display the customization buttons.

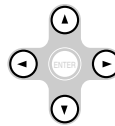

- 2 While the customization buttons are displayed, press ◀/▶ to select the desired function then press ENTER.

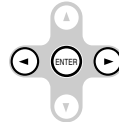

(If the customization buttons disappear, return back to step 1.)

**Timer:** While selected, press **ENTER** to choose the desired viewing time (second, approx.).

**Repeat:** While selected, press **ENTER** to choose the mode.

**ON:** Repeats slide show playback of all photographs of the selection arranged by “Set Order” setting.  
**OFF:** Plays slide show once.

**Set Order:** After having selected this and pressed **ENTER**, the menu changes as follows. Perform 1) to 3) below.

- 1) Press ▲/▼/◀/▶ to select a photo to move, then press **ENTER**.

e.g.



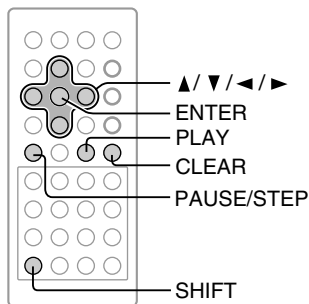

- 2) Press ▲ / ▼ / ◀ / ▶ to select a location where you want to move the photo.

e.g.



- 3) Press **ENTER**.

The selected photo is moved to the front of the one you specified.

e.g.



To recover the latest modification of photograph positions:

Press ▲ / ▼ / ◀ / ▶ to select “Undo” and press **ENTER**.

To hide a photo:

Press ▲ / ▼ / ◀ / ▶ to select a photo you want not to display in the slide show, then press **CLEAR** while pressing **SHIFT**.

To show the photo, press **CLEAR** while pressing **SHIFT** again. (“Undo” cannot substitute for this operation.)

To reset according to original CD or card order:

Press ▲ / ▼ / ◀ / ▶ to select “Reset” and press **ENTER**.

- 3 To start a slide show, press **PLAY**, or press ▲ / ▼ / ◀ / ▶ to select “Start Show” and press **ENTER**.

#### Notes

- These customizations are temporary and are not saved. These are automatically deleted after exiting Digital Photo Viewer playback.
- Slide Show starts also by selecting “Slide Show” button. The show will start from the first photograph of the selection arranged by “Set Order” setting.
- The Slide Show customization buttons do not disappear automatically. Be careful not to leave the still image on screen for a prolonged period, to avoid etching the image on the TV screen.
- The time it takes to display an image varies depending on the file format.

## *Viewing JPEG Files - Digital Photo Viewer - (continued)*

### **JPEG files compatibility**

Discs and pixels whose compatibility with this player has been confirmed by TOSHIBA are as follows.

Fuji Color CD  
Kodak Picture CD  
NORITSU QSS CD  
CANON

However, the following requirements apply to files that can be played on this player.

1. Pixels: under 6.0 mega pixels
2. File format: Exif
3. Total number of files: Less than 1000

Memory cards whose compatibility with this player has been confirmed by TOSHIBA are as follows.

1. Pixels: under 6.0 mega pixels
2. File format: DCF
3. Total number of files: Less than 1000

#### **Note**

Images may not be displayed depending on the resolution and the size of files.



Certain portions of this software copyright ©1996-2003 by Planetweb, Inc. All rights reserved.

Portions of the software are covered by the following copyright:

Copyright ©1989, 1991, 1992, 1993 Regents of the University of California. All rights reserved.

Redistribution and use in source and binary forms are permitted provided that the above copyright notice and this paragraph are duplicated in all such forms and that any documentation, advertising materials, and other materials related to such distribution and use acknowledge that the software was developed by the University of California, Berkeley. The name of the University may not be used to endorse or promote products derived from this software without specific prior written permission. THIS SOFTWARE IS PROVIDED "AS IS" AND WITHOUT ANY EXPRESS OR IMPLIED WARRANTIES, INCLUDING, WITHOUT LIMITATION, THE IMPLIED WARRANTIES OF MERCHANTABILITY AND FITNESS FOR A PARTICULAR PURPOSE.

Portions of the software are covered by the following copyright:

Copyright ©1993. Original Copyright Ricoh Corp. All rights reserved.

Outline font rasterizer is the Copyright property of Ricoh Corp.

UNDER NO CIRCUMSTANCES AND UNDER NO LEGAL THEORY SHALL NETSCAPE OR ITS SUPPLIERS BE LIABLE TO LICENSEE OR ANY OTHER PERSON FOR ANY INDIRECT, SPECIAL, INCIDENTAL, OR CONSEQUENTIAL DAMAGES OF ANY CHARACTER INCLUDING WITHOUT LIMITATION ANY COMMERCIAL DAMAGES OR LOSSES, EVEN IF NETSCAPE HAS BEEN INFORMED OF THE POSSIBILITY OF SUCH DAMAGES.

In no event will Netscape's liability for any claim, whether in contract, tort, strict liability or otherwise, exceed the license fee paid to Netscape for the Software.

Certain portions of this software copyright ©1996 Netscape Communications Corp.



# **Advanced playback**

Customizing the performance of your player.

- **Accessing a Specific Location Directly**
- **Zooming a Picture**
- **Selecting a Camera Angle**
- **Selecting Subtitles**
- **Selecting a Language**

## Accessing a Specific Location Directly

You can access a specific location by entering its corresponding time (hours, minutes, seconds).

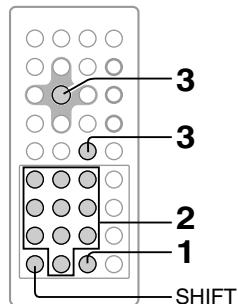

### DVD-V DVD-A VCD CD Entering the time counter of the desired location

#### 1 Press T while pressing SHIFT several times.



You may have to press further depending on the disc. Press the button repeatedly until the clock icon is highlighted.

e.g.



#### 2 Press the number buttons to enter the time.

e.g.

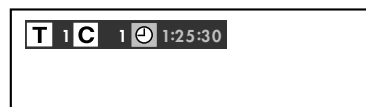

#### 3 Press PLAY or ENTER.



Playback starts from the desired location.



#### Notes

- Some discs may not respond to this process.
- Some scenes may not be located precisely as you specified.
- This method for accessing specific locations is available only within the current title of the DVD video disc or within the current track of the VIDEO CD/audio CD.

# Zooming a Picture

You can magnify areas within a picture.

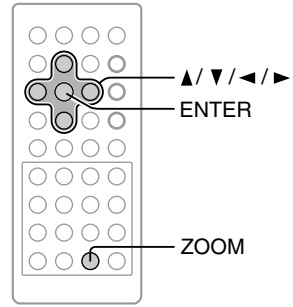
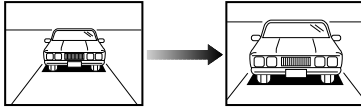

## DVD-V DVD-A VCD CD Zooming a picture

### Press ZOOM during normal, slow or still playback.



The player enters the zoom playback mode, and a monitor display and icon appear.

e.g.

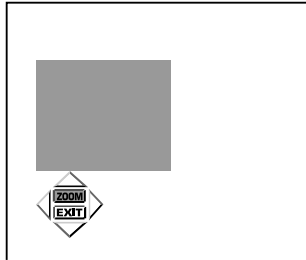

**ZOOM** : As you repeatedly press the ENTER (or ZOOM) button while “ZOOM” is selected, the magnification level changes. Variation of the levels includes image reduction.

**EXIT** : If you press the ENTER button while “EXIT” is highlighted, you can turn off the icon, keeping the current magnification level.

You can shift the highlight within the icon by the ▲ / ▼ / ◀ / ▶ buttons.

If you press and hold the ▲ / ▼ / ◀ / ▶ buttons, the zoom point shifts.



### ■ To hide the monitor display and icon during zoom playback

Press ▲ / ▼ / ◀ / ▶ to select “EXIT,” and press ENTER.

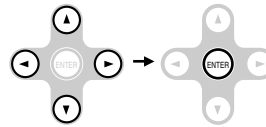

### ■ To resume normal playback

Press ZOOM repeatedly until the monitor display and icon disappear.

Alternatively press ▲ / ▼ / ◀ / ▶ to select “ZOOM” on the icon, and press ENTER repeatedly until the monitor display and icon disappear.

### Notes

- Some discs may not respond to zoom feature.
- During some scenes, the buttons may not work as described.
- Zooming does not work on characters selected on menus.
- While the icon is displayed, ▲ / ▼ / ◀ / ▶ / ENTER cannot work on menus included on DVD video discs. If you want to view the menus, cancel the zoom playback.
- The magnification level varies depending on the picture size you select. [68]
- When using a DVD audio disc that includes pictures, this operation may be permitted in some picture segments.

# Selecting a Camera Angle

If a scene was recorded with multiple angles, you can easily change the camera angle of the scene you are viewing.

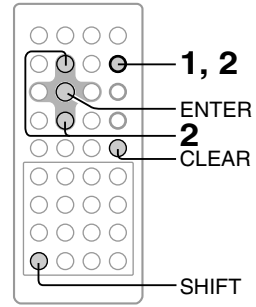
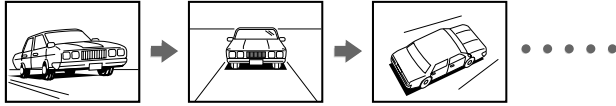

## Changing the camera angle

### 1 Press ANGLE while playing a scene recorded with multiple angles.



While playing a scene recorded with multiple angles, the angle icon (📷) appears on the screen. Press the ANGLE button while the angle icon is displayed.

e.g.



### 2 Press ANGLE or ▲ / ▼ while the angle number is displayed on the screen.



Each time you press the ANGLE or ▲ / ▼ buttons, the camera angle changes.



You can change the camera angle directly by pressing the number buttons corresponding to an angle number instead of using the ▲ / ▼ buttons.

### ■ To turn off the angle number display

Press **CLEAR** while pressing **SHIFT** or press **ENTER**.

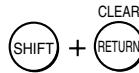

### Notes

- After selecting angle, it will take a few moments to change the camera angle of the scene you are viewing.
- You can change the camera angle during still playback. The camera angle changes to the new setting when you resume normal playback.
- If you pause a picture immediately after changing a camera angle, the resumed playback picture may not display the new camera angle.
- When using a DVD audio disc that includes pictures recorded from multiple angles, this operation may be permitted in some picture segments.

# Selecting Subtitles

You can display subtitles on the screen and select a subtitle language from those included on the DVD video disc.

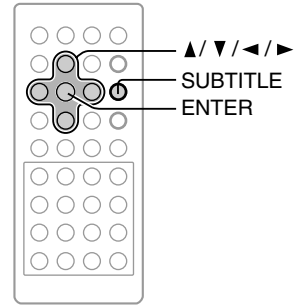
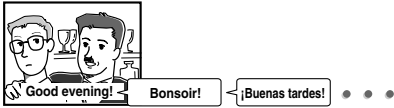

## Selecting a subtitle language

### 1 Press SUBTITLE during playback.

SUBTITLE



The current subtitle setting is displayed.

e.g.



The abbreviation of the language appears instead of the language name. Refer to the list of languages and their abbreviations. [75](#)

### 2 Press SUBTITLE or ▲ / ▼ while the subtitle setting is displayed on the screen.

SUBTITLE



Each time you press the SUBTITLE or ▲ / ▼ button, the subtitle languages included on the DVD video disc change.

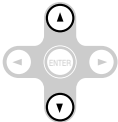

To turn off the subtitle setting display, press the ENTER button.

### ■ To turn subtitles on or off

1 Press **SUBTITLE** during playback.

SUBTITLE



2 Press ◀ / ▶ while the subtitle setting is displayed on the screen, to select "On" or "Off".

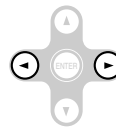

### Notes

- Some DVD video discs display subtitles automatically, and you cannot turn them off even if you set the subtitle function to off.
- During some scenes, subtitles may not appear immediately after you select "On".
- Some DVD video discs will allow you to make subtitle selections and turn subtitles on or off only via the disc menu.

### Notes

- When you turn on the player or replace a disc, the player returns to the initial default setting [71](#). When you select a subtitle language which is not included on the disc, the player plays a prior language programmed on the disc.
- During some scenes, the subtitles may not appear immediately after you change the subtitle language by pressing the ▲ / ▼ buttons.
- When using a DVD audio disc that includes pictures accompanied with subtitles, this operation may be permitted in some picture segments.

# Selecting a Language

You can select a preferred language and sound recording system from those included on the disc.

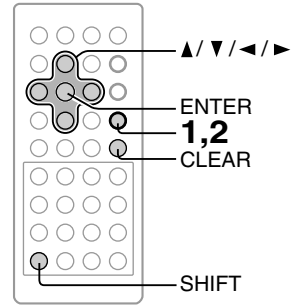
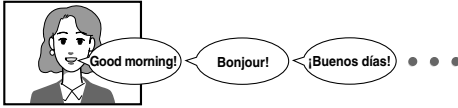

## Selecting a playback audio setting

### 1 Press AUDIO during playback.



The current audio setting is displayed.

e.g.



The abbreviation of the language appears instead of the language name. Refer to the list of languages and their abbreviations. [75](#)

### 2 Press AUDIO or ▲/▼ while the audio setting is displayed on the screen.



Each time you press the AUDIO or ▲/▼ button, the audio settings included on the DVD video disc change.

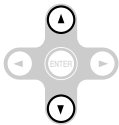

If you press the ◀/▶ buttons, you can select output sound format.

To turn off the audio setting display, press the CLEAR button while pressing the SHIFT button or press the ENTER button.

### Selecting audio streams of DVD audio discs

During playback, perform steps 1 and 2. At step 2, you can switch streams 1 and 2.

e.g.

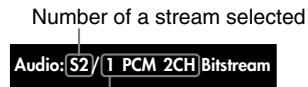

Number and information of a stream currently played

If a DVD audio disc does not include a stream you have selected, the player plays another stream.

### Selecting sound channels of VIDEO CDs

During playback, press AUDIO repeatedly to select the sound channel.



#### Notes

- Some discs allow you to change audio selections only via the disc menu. If this is the case, press the MENU button and choose the appropriate language from the selections on the disc menu.
- When you turn on the player or replace a disc, the player returns to the initial default setting [71](#).
- If you select a sound track which is not included on the disc, the player plays a prior sound track programmed on the disc.
- When you change the audio setting during playback of a DVD audio disc, playback may return to the beginning of the current track.



## ■ Output sound conversion table (sampling frequency/quantization bit)

Discs	Sound recording system	Audio selection from the menu <b>[66]</b> <b>[69]</b> and outputs				
		"Bitstream"		"PCM"		
		BITSTREAM/PCM jack	Speakers/AV OUT jack/ Headphone jacks	BITSTREAM/PCM jack	Speakers/AV OUT jack/ Headphone jacks	
DVD video discs	Dolby Digital	Bitstream	48 kHz/20 bit	48 kHz/20 bit	48 kHz/20 bit	
	Linear PCM	48 kHz/16 bit	48 kHz/16 bit	48 kHz/16 bit	48 kHz/16 bit	
		48 kHz/20 bit	48 kHz/20 bit	48 kHz/20 bit	48 kHz/20 bit	
		48 kHz/24 bit	48 kHz/24 bit	48 kHz/24 bit	48 kHz/24 bit	
		96 kHz/16 bit	96 kHz/16 bit	96 kHz/16 bit	96 kHz/16 bit	
		96 kHz/20 bit	96 kHz/20 bit	96 kHz/20 bit	96 kHz/20 bit	
	96 kHz/24 bit	96 kHz/24 bit	96 kHz/24 bit	96 kHz/24 bit		
	DTS	Bitstream	–	–	–	
	MPEG1, MPEG2	Bitstream	48 kHz/16 bit	48 kHz/16 bit	48 kHz/16 bit	
	VIDEO CDs	MPEG1	44.1 kHz/16 bit	44.1 kHz/16 bit	44.1 kHz/16 bit	44.1 kHz/16 bit
Audio CDs	Linear PCM 44.1 kHz/16 bit	44.1 kHz/16 bit	44.1 kHz/16 bit	44.1 kHz/16 bit	44.1 kHz/16 bit	
	DTS	Bitstream	(Noise)	Bitstream	(Noise)	
DVD audio discs	Linear PCM or Packed PCM	44.1 kHz/16 bit	–	44.1 kHz/16 bit	–	44.1 kHz/16 bit
		48 kHz/16 bit	–	48 kHz/16 bit	–	48 kHz/16 bit
		44.1 kHz/20 bit	–	44.1 kHz/20 bit	–	44.1 kHz/20 bit
		48 kHz/20 bit	–	48 kHz/20 bit	–	48 kHz/20 bit
		44.1 kHz/24 bit	–	44.1 kHz/24 bit	–	44.1 kHz/24 bit
		48 kHz/24 bit	–	48 kHz/24 bit	–	48 kHz/24 bit
		88.2 kHz/16 bit	–	88.2 kHz/16 bit	–	88.2 kHz/16 bit
		96 kHz/16 bit	–	96 kHz/16 bit	–	96 kHz/16 bit
		88.2 kHz/20 bit	–	88.2 kHz/20 bit	–	88.2 kHz/20 bit
		96 kHz/20 bit	–	96 kHz/20 bit	–	96 kHz/20 bit
		88.2 kHz/24 bit	–	88.2 kHz/24 bit	–	88.2 kHz/24 bit
		96 kHz/24 bit	–	96 kHz/24 bit	–	96 kHz/24 bit
		176.4 kHz/16 bit	–	176.4 kHz/16 bit	–	176.4 kHz/16 bit
		192 kHz/16 bit	–	192 kHz/16 bit	–	192 kHz/16 bit
		176.4 kHz/20 bit	–	176.4 kHz/20 bit	–	176.4 kHz/20 bit
		192 kHz/20 bit	–	192 kHz/20 bit	–	192 kHz/20 bit
		176.4 kHz/24 bit	–	176.4 kHz/24 bit	–	176.4 kHz/24 bit
192 kHz/24 bit	–	192 kHz/24 bit	–	192 kHz/24 bit		

- DVD audio playback will always be 2-channel output. Therefore, discs with down mix restrictions cannot be played.
- DVD audio playback is not outputted from BITSTREAM/PCM jack.
- Some multi-channel recorded DVD audio discs may not permit 2-channel mix playback. If you play such a disc on this player connecting two speakers, you may obtain only the original left and right channel sound, and may not hear other channels that are included in the multichannel mix. This is due to playback restrictions of the disc. Refer to instructions of the disc for details. Such discs may include the same contents recorded in stereo. Select this, if available, by changing the audio setting.
- Signals of 88.2kHz or higher from the BITSTREAM/PCM jack are down converted to 44.1 kHz or 48 kHz when:
  - "3D" is selected. **[63]**
  - "PCM Down Sampling" is set to "On". **[69]**
  - a copyright protected disc is played.
- Quantization will be limited to 16 bits in a copyright protected disc.



# Quick control

Simple use of a single button and the cursor control enables you to direct your playback, without manipulating many actual buttons.

- **Using the Virtual Remote Control - V-REMOTE -**
- **Selecting the Playback Function - QUICK -**
- **Accessing Features - NAVI -**

# Using the Virtual Remote Control

## - V-REMOTE -

Pressing 2 buttons simultaneously displays a graphics based on-screen remote control that allows you to control playback as if you were doing it from the actual remote control.

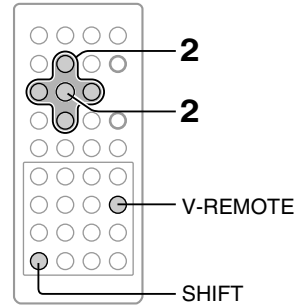

DVD-V DVD-A VCD CD **Using the virtual remote control**

### 1 During playback, press V-REMOTE while pressing SHIFT.

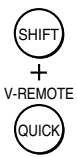

The virtual remote control appears. For the meaning of each icon, see right.

e.g. DVD-V

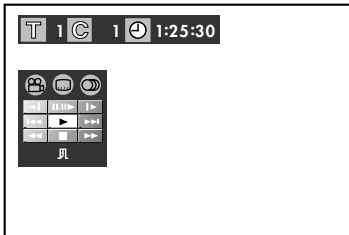

### 2 Press ▲/▼/◀/▶ to select the item, then press ENTER.

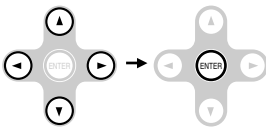

### ■ To turn off the Virtual Remote Control

Press V-REMOTE while pressing SHIFT.

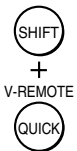

**Note**  
Some discs may not permit this operation.

### ■ Icons and features

See the pages in [ ] for details on the features.

Icon	Function	Page
T*	Current title/track number	-
G*	Current group number	-
C*	Current chapter number	-
⌚*	Elapsed time of the current title/track	-
🔊**	Audio setting	48
🗣️**	Subtitle setting	47
🎬**	Angle setting	46
⏮️	Reverse slow motion playback	26
⏸️	Pause / Frame by frame playback	25
▶️	To begin slow motion playback	26
⏮️	Playback starts from the beginning of the current chapter or track.	29
▶️	Normal playback	21
⏭️	To locate succeeding chapters or tracks.	29
⏮️	Fast reverse playback	25
■	To stop playback.	22
⏭️	Fast forward playback	25
🔌	To turn off the Virtual Remote.	

\* You can access a desired location. After step 2, perform the steps below:

T / G / C : steps 3 to 5 on 28

⌚ : steps 2 and 3 on 44

\*\* After step 2, a sub menu will appear. Perform step 2 on the page in [ ].

# Selecting the Playback Function - QUICK -

Pressing one button can display a list of playback functions which are relevant to your current playback mode. You can check and modify them from the list.

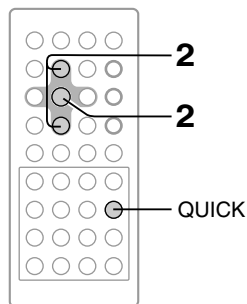

## DVD-V DVD-A VCD CD Selecting the playback function

### 1 During playback, press QUICK.

V-REMOTE



The following on-screen display appears.  
(The actual display will vary depending on the playback status.)

e.g. DVD-V

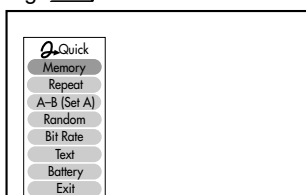

### 2 Press ▲ / ▼ to select the item, then press ENTER.

e.g. The mode menu appears.

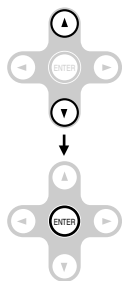

### ■ Quick menu

- Memory :** To combine titles, groups, chapters or tracks, and play them in the desired order. Up to 30 programs can be set. **[54]**
- Repeat :** To play titles, groups, chapters or tracks repeatedly. **[55]**
- A-B (Set A) :** To define a segment to play repeatedly. **[56]**
- Random :** To play titles, groups, chapters or tracks in random order. **[56]**
- Bit Rate :** To activate the bitrate display.  
(Bit rate: data transfer rate (Mbit/s)  
Amount of picture, sound and subtitle data in the DVD video disc transferred per second.  
The larger the value, the more data processed, but this does not necessarily insure better picture quality.)
- Text :** To activate the Text display.  
Text display:  
Displays DVD-Text data if included on the disc.  
When playing a DVD audio disc, displays Album Text data if included on the disc. However, Track Text data is not displayed.  
(Some content on the disc may not be displayed properly depending on the disc.)
- Battery :** To display battery level while connected to the battery. **[86]**
- Exit :** To quit the on-screen display.

### Note

Pressing the QUICK button again also exits the on-screen display.

## Selecting the Playback Function - QUICK - (continued)

### Playing in the selected mode

#### Memory playback DVD-V DVD-A VCD CD

You can combine your favorite titles groups, chapters, or tracks and play them in the order you determine. You can program up to 30 selections into the memory.

Select "Memory" and press the ENTER button. The on-screen display shown below appears.

TG: Title number or group number  
CT: Chapter number or track number

e.g.

Memory List	
1 TG: -- CT: ---	
2 TG: -- CT: ---	
3 TG: -- CT: ---	
4 TG: -- CT: ---	
5 TG: -- CT: ---	
6 TG: -- CT: ---	
7 TG: -- CT: ---	

- 1 Enter the number in the order you wish to playback, then press **ENTER**.

Each time you press the ◀/▶ button, the spaces of "TG" and "CT" are highlighted in turn. Highlight what you want to enter, then press the corresponding number buttons.

To select another chapter in the same title, you do not need to enter the title number.

To select another track in the same group, you do not need to enter the group number.

When using a video CD/audio CD, enter the track number.

#### Note

The space of "TG" may be a number. Neglect this number when using a VIDEO CD/audio CD.

- 2 Press **PLAY** while the display appears on the screen.



The player starts memory playback.

#### ■ To change the programmed selections

- 1 While the display appears on the screen, press ▲/▼/◀/▶ to move the highlighted bar to the item you wish to change.
- 2 Correct the numbers.

#### ■ To cancel the programmed selections

- 1 While the display appears on the screen, press ▲/▼ to move the highlighted bar to the item you want to cancel.
- 2 Press **CLEAR** while pressing **SHIFT**.

#### ■ To resume normal playback from memory playback

Press **CLEAR** while pressing **SHIFT**.



The quick menu can also be available.

#### Notes

- Some discs may not permit memory playback operation.
- The memory currently on play can be repeated. Select Memory Repeat from the quick menu during the memory playback.
- When the display appears on the screen, if you press the RETURN button, the display disappears.
- The programmed selections will be cleared when:
  - you turn off the player.
  - you open the disc cover.

## Repeat playback DVD-V DVD-A VCD CD

You can play a specific title, group, chapter, or track repeatedly.

Select "Repeat" and press the ENTER button. The on-screen display shown below appears.

e.g. DVD-V

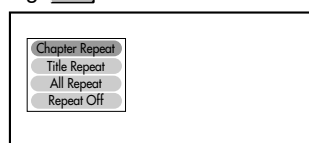

### 1 Press ▲/▼ to select.

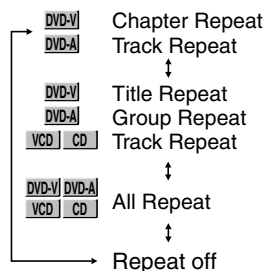
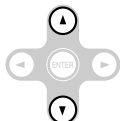

Chapter Repeat: Repeats the current chapter.  
 Track Repeat: Repeats the current track.  
 Title Repeat: Repeats the current title.  
 Group Repeat: Repeats the current group.  
 All Repeat: Repeats the entire disc.  
 Repeat Off: Resumes normal playback.

If you select the mode during playback, the player automatically starts repeat playback after finishing the current title, chapter, group or track.

### 2 Press PLAY.



The player starts repeat playback. Press the PLAY button within about 5 seconds after you select the repeat playback mode.

### ■ To resume normal playback

Press CLEAR while pressing SHIFT.



The quick menu can also be available.

### Note

Some discs may not permit repeat operation.

# Selecting the Playback Function - QUICK - (continued)

## Playing in the selected mode

### A-B Repeat DVD-V VCD CD

You can repeat playback of a specific segment.

Select "A-B (Set A)", and at the beginning of the segment (point A) press the ENTER button. The on-screen display shown below appears.

The beginning of the segment (point A) has been memorized.

e.g.



1 Press **ENTER** at the end of the segment (point B).



The player automatically returns to point A and starts repeat playback of the selected segment (A-B).

#### ■ To resume normal playback

Press **CLEAR** while pressing **SHIFT**.



The quick menu can also be available.

#### Notes

- Some discs may not permit A-B repeat operation.
- You can specify a segment only within the current title or track.
- You cannot set the A-B repeat function for a segment that includes multiple camera angles **[46]**.
- There may be a slight difference between point A and the location where playback actually resumes, depending on the disc.

### Random playback DVD-V DVD-A VCD CD

You can play titles, groups, chapters within a title, or tracks in random order.

Select "Random" and press the ENTER button. The on-screen display shown below appears.

e.g. DVD-V

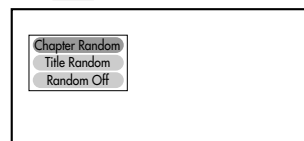

1 Press **▲ / ▼** to select.



<p><span>DVD-V</span> Chapter Random</p> <p><span>DVD-A</span> Track Random</p> <p style="text-align: center;">↓</p> <p><span>DVD-V</span> Title Random</p> <p><span>DVD-A</span> Group Random</p> <p><span>VCD</span> Track Random</p> <p><span>CD</span> Track Random</p> <p style="text-align: center;">↓</p> <p>Random Off</p>	<p>Plays the chapters within the current title in random order.</p> <p>Plays the tracks within the current group in random order.</p> <p>Plays titles in random order.</p> <p>Plays groups in random order.</p> <p>Plays tracks in random order.</p> <p>Plays tracks in random order.</p> <p>Resumes normal playback.</p>
--	---

If you select any of the above modes during playback, the player automatically starts random playback after finishing the current title, group, chapter, or track.



## 2 Press **PLAY**.



The player starts random playback.  
Press the **PLAY** button within about 5 seconds  
after you select the random playback mode.

### ■ To resume normal playback

Press **CLEAR** while pressing **SHIFT**.

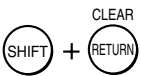

The quick menu can also be available.

#### **Note**

Some discs may not permit random playback operation.

# Accessing Features - NAVI -

The NAVI menu provides an icon based display from which you can easily access key playback functions or settings.

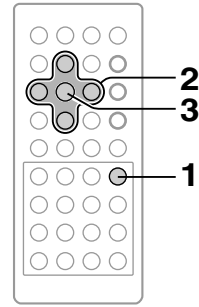

DVD-V DVD-A  
VCD CD

## NAVI menu items

### 1 Press NAVI.



The NAVI menu appears.

e.g. DVD-V

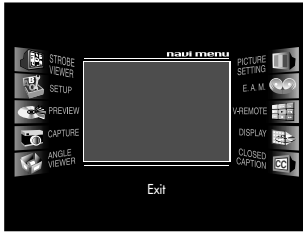

### 2 Press ▲/▼/◀/▶ to select icon.

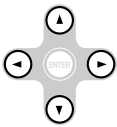

For details on each feature, refer to the list on the next page.

### 3 Press ENTER.



Menu selection items appear.

### 4 Refer to the list on the next page and follow the instructions detailed on subsequent pages.

### ■ To exit the NAVI menu

Press NAVI.





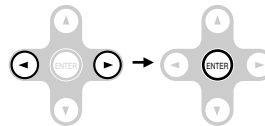







Alternatively press ◀/▶ to remove the highlight from an icon to the center position, and press ENTER.



### Note

Some features cannot be accessed depending on the disc.

## Navi menu selections

	Strobe Viewer	You can divide a desired scene into stop action frames for careful analysis.	60
	Setup	You can change the default settings to customize performance to your preference.	66
	Preview	You can display thumbnail views of the first scenes of titles or chapters and select a preferred one to commence playback.	60
	Capture	You can sample a scene from a playback picture and transform it into a background picture.	61
	Angle Viewer	You can display all camera angles simultaneously and select your preferred one from them.	61
	Picture Setting	You can fine adjust picture quality and store up to 3 custom picture settings in the memory of the player.	62
	E.A.M.	You can easily switch to a preferred audio enhancement.	63
	V-Remote	You can control key playback functions using the graphics based on-screen remote control.	52
	Display	You can view information about a disc and its operational status on the TV screen.	64
	Closed Caption	You can display closed caption included on a DVD disc without connecting a closed caption decoder to your TV.	64

# Accessing Features - NAVI - (continued)

## NAVI menu items

### Strobe Viewer



You can divide a desired scene into stop action frames for careful analysis.

After selecting this icon and pressing ENTER, the following on-screen display appears:

e.g.

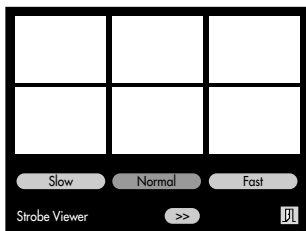

1 Press ▲ / ▼ / ◀ / ▶ to select.



- Slow: Still pictures at shorter intervals.
- Normal: Still pictures at normal intervals.
- Fast: Still pictures at longer intervals.
- >>: To view the next series of 6 pictures.
- JL: To quit the on-screen display.

2 Press ENTER.



**Note**

Some discs or scenes may not permit this operation.

### Preview



You can display thumbnail views of the first scenes of titles or chapters and select a preferred one to commence playback.

After selecting this icon and pressing ENTER, the following on-screen display appears:

e.g.

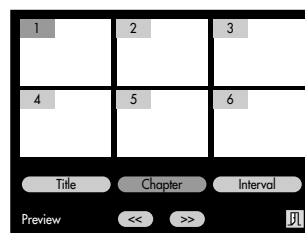

1 Press ▲ / ▼ / ◀ / ▶ to select.

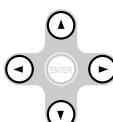

- 1 - 6: To locate the scene.
- Title: To display the first scenes of titles (1 to 6).
- Chapter: To display the first scenes of chapters (1 to 6).
- Interval: To display scenes at intervals of about 10 minutes apart.
- <<: To go to the previous page.
- >>: To go to the next page.
- JL: To quit the on-screen display.

2 Press ENTER.



**Notes**

- Some discs or scenes may not permit this operation.
- Some items may not be selected depending on the disc or scene.
- Some of the first scenes may not be picked up depending on the disc.

## Capture



You can sample a scene from a playback picture and transform it into a background picture.

After selecting this icon and pressing ENTER, the following on-screen display appears:

e.g.

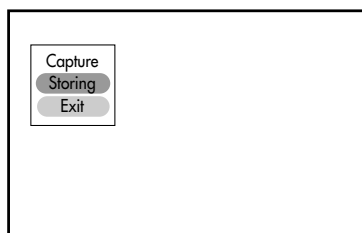

- 1 Pause the playback at the scenes you wish to store.
- 2 Press ▲/▼ to select.

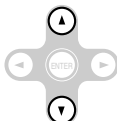

Storing: To sample and store the current picture in the player memory.

Exit: To quit the on-screen display.

- 3 Press ENTER.



The stored picture will be displayed as a background picture when the player is in the stop mode. It is necessary to confirm this process via the setup menu **72**.

### Notes

- You can store only one picture. Storing a new picture will erase the old one.
- No operations are permitted in process of sampling and storage of background picture.
- Some discs or scenes may not permit this operation.

## Angle Viewer



You can display all camera angles simultaneously and select your preferred one from them.

After selecting this icon and pressing ENTER, the following on-screen display appears:

e.g.

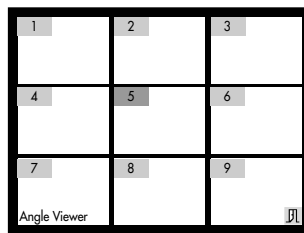

When the scene contains 9 camera angles:

- 1 Press ▲/▼/◀/▶ to select.



1-9: To select the camera angle.

⏏: To quit the on-screen display.

- 2 Press ENTER.



### Note

Some discs or scenes may not permit this operation.

# Accessing Features - NAVI - (continued)

## NAVI menu items

### Picture Setting



You can fine adjust picture quality and store up to 3 custom picture settings in the memory of the player.

After selecting this icon and pressing ENTER, the following on-screen display appears:

e.g.



1 Press ▲ / ▼ to select, and press **ENTER**.

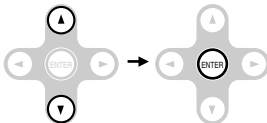

(Standard) : Normal setting.  
1, 2, 3: Select the desired custom memory number. (Follow steps 2 to 4 below.)

2 Press ▲ / ▼ to select the element.

e.g. When you select "Color":

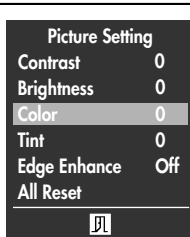

3 Press **ENTER**.

The sub menu appears.

4 Press ◀ / ▶ to adjust the value, and press **ENTER**.

e.g.



Contrast : -7 (Lower) to +7 (Higher)  
 Brightness : -7 (Darker) to +7 (Brighter)  
 Color: -7 (Paler) to +7 (Deeper)  
 Tint : -7 (Redder) to +7 (Greener)  
 Edge Enhance\*1 : On / Off  
 All Reset : To restore all the elements to their normal setting. A message will appear. Follow the procedure displayed on-screen.

\*1: To enhance picture edges.

### Note

These settings will not adjust the picture quality of a TV connected to the player.

**E.A.M.: Enhanced Audio Mode**

You can obtain expansive virtual surround sound effects from just two speakers or headphone.

Select this icon and press the ENTER button. The on-screen display shown below appears.

e.g.

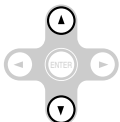
**1** Select the sound enhancement by pressing ▲ / ▼.

Each time you press the button, the sound enhancement changes.



**Normal:**  
Normal sound.



**3D: \***  
To obtain expansive virtual surround sound effects from just two speakers.



**NHP (Natural Headphone):**  
To obtain expansive virtual surround sound effects when using headphone.



**Dialogue:**  
To control critical center channel information to make dialogue more intelligible (only when playing a DVD video disc recorded on the Dolby Digital recording system).

- To use this enhancement on sounds output from the BITSTREAM/PCM jack, be sure to set "Audio Out Select" to "PCM." [69](#)

**2** To exit the audio enhancement selection press **ENTER**.

Alternatively leave the player unattended for about 5 seconds after having made a selection.

**Notes**

- Actual effects to sounds may vary depending on the speaker system. Make the selection to your preference.
- Actual effects to sounds may vary depending on the disc.
- When the player is connected to an amplifier equipped with Dolby Surround Pro Logic, select "Normal". Otherwise, Dolby Surround Pro Logic may function differently than usual.
- Selecting "Dialogue" disables the "Dynamic Range Control" function [70](#).
- NHP cannot function during DVD audio or CD playback.

\* Spatializer® 3-Dimensional Sound Processing provided by Desper Products, Inc. Certain audio features of this product manufactured under a license from Desper Products, Inc., Spatializer® and the circle-in-square device are trademarks owned by Desper Products, Inc.

## Accessing Features - NAVI - (continued)

### NAVI menu items

#### Display



You can view information about a disc and its operational status on the TV screen.

After selecting this icon and pressing ENTER, the following on-screen display appears:

e.g.

```
Title : 1
Chapter : 23
Time : 1:23:45
Audio : ENG 1   D 2CH
Subtitle : ENG 1 On
Angle : 1/3
E.A.M. : Normal
Audio Out Select : Bitstream
Zoom : Off
Chapter Repeat
```

To quit the on-screen display, press **ENTER**.

#### Notes

- Some discs or scenes may not permit this operation.
- When playing a DVD audio disc, the area may show the sound recording system (sampling frequency and quantization bit) of the disc, and the corresponding speakers using the following symbols.

C (mono):

Recorded in monaural.

L, R:

(L: Left, R: Right)

Recorded in 2ch stereo.

Lf, Rf, C, LFE, S, Ls, Rs:

(Lf: Left front, Rf: Right front, C: Center,

LFE: Subwoofer, S: Surround,

Ls: Left surround, Rs: Right surround)

Recorded in multi-channel.

#### Closed Caption



You can display closed caption included on a DVD disc without connecting a closed caption decoder to your TV.

After selecting this icon and pressing ENTER, the following on-screen display appears:

e.g.



- 1 Press **▲ / ▼** to select.



- On: To display closed caption.
- Off: To disable closed caption.

- 2 Press **ENTER**.



#### Notes

- While you are using on-screen displays (including the above one), you cannot view closed caption.
- When "On" is selected, some displays such as "▶" may be disabled.



# Function setup

You can change the default settings to customize performance to your preference.

- **Customizing the Function Settings**
- **Table of Languages**

# Customizing the Function Settings

You can change the default settings to customize performance to your preference.

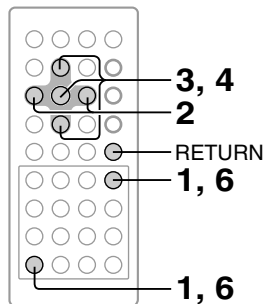

DVD-V DVD-A  
VCD CD

## Setting procedure

**1** Press **SETUP** while pressing **SHIFT** during stop.



The following on-screen display appears.

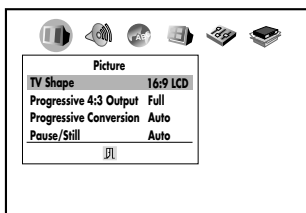

**2** Press **◀/▶** to select a symbol for the setting you want to change.

(See the next page.)



Picture performance settings



Output sound settings



Language settings



Display settings



Operational settings



Initial settings

**3** Press **▲/▼** to select the setting you want to change, then press **ENTER**.

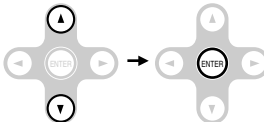

**4** Change the selection by **▲/▼** or other buttons, by referring to the corresponding pages **67**, then press **ENTER**.

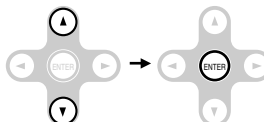

**5** Repeat steps 3 and 4 to change other settings.

To select another operation, go back to step 2.

**6** Press **SETUP** while pressing **SHIFT**.



The on-screen display disappears.







■ **To return to the previous display**

Press **RETURN**.



**Notes**

- The on-screen display disappears when you press the **SETUP** button while pressing the **SHIFT** button.
- The **SETUP** button can function even during normal playback, however some operations may be inaccessible, and a message will appear. In this case, try again after playback is stopped.

Setting		Details	Page
	TV Shape	<u>DVD-V</u>	To select a picture size according to the aspect ratio of your TV. 68
	Progressive 4:3 Output	<u>DVD-V</u> <u>VCD</u>	To select the video output of pictures recorded in 4:3 format. (Only when connected to a PROGRESSIVE TV.) 68
	Progressive Conversion	<u>DVD-V</u>	To select the system of output signal. (Only when connected to a PROGRESSIVE TV.) 68
	Pause/Still	<u>DVD-V</u>	To select the resolution of still pictures. (Field/Frame) 68
	PCM Down Sampling	<u>DVD-V</u> <u>DVD-A</u>	To select a sound processing option according to performance of the connected equipment. (Only when the BITSTREAM/PCM (DIGITAL) AUDIO OUT jack is connected.) 69
	Audio Out Select	<u>DVD-V</u> <u>DVD-A</u> <u>VCD</u> <u>CD</u>	To select an output sound format corresponding to your system connection. 69
	Dynamic Range Control	<u>DVD-V</u>	To turn on or off a function that makes faint sounds easier to hear even if you lower the volume during late hours playback. 70
	Karaoke Vocal	<u>DVD-V</u>	To turn on or off the vocal output during DVD KARAOKE disc playback. 70
	On-Screen Language	<u>DVD-V</u> <u>DVD-A</u> <u>VCD</u> <u>CD</u>	To select a preferred language for on-screen displays. 70
	Disc Menu Language	<u>DVD-V</u>	To select a preferred language for disc menus. 70
	Audio Language	<u>DVD-V</u>	To select a preferred language for the sound track. 71
	Subtitle Language	<u>DVD-V</u>	To select a preferred language for subtitles. 71
	On-Screen Displays	<u>DVD-V</u> <u>DVD-A</u> <u>VCD</u> <u>CD</u>	To turn on or de-activate the operational status display on the TV screen. 72
	Background	<u>DVD-V</u> <u>DVD-A</u> <u>VCD</u> <u>CD</u>	To select the background color or background picture. 72
	Screen Saver	<u>DVD-V</u>	To turn the screen saver on or off. 72
	Parental Lock	<u>DVD-V</u>	To turn the parental lock function on or off. 72
	Title/Group Stop	<u>DVD-V</u> <u>DVD-A</u>	To turn on or off a feature that automatically stops playback after a title/group has been viewed. 74
	PBC	<u>VCD</u>	To use the menu screen when playing a PBC-controllable VIDEO CD. 74
	Priority Contents 1	<u>DVD-V</u> <u>DVD-A</u>	To select the playback priority between DVD video and DVD audio format signals. 74
	Priority Contents 2		To select the playback priority between JPEG (picture) files and MP3/WMA (audio) files. 74
	Initialize	<u>DVD-V</u> <u>DVD-A</u> <u>VCD</u> <u>CD</u>	To restore all settings to the factory set. 74

- When using a DVD audio disc that includes pictures, some settings marked DVD-V may be effective.

# Customizing the Function Settings (continued)

## Setting details

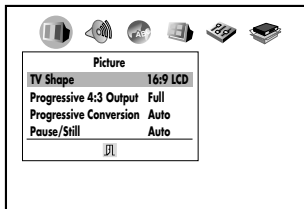

### TV Shape DVD-V

**4:3 Letterbox:** Select when a standard 4:3 TV is connected. Displays theatrical images with masking bars above and below the picture. When playing a source of 16:9 picture size.



**4:3 Normal:** Select when a standard 4:3 TV is connected. Displays pictures cropped to fill your TV screen. Either or both sides of the picture are cut off.



**16:9 Widescreen:** Select when a 16:9 wide TV is connected.

**16:9 LCD:** Select when you use the LCD of this player. Displays pictures in the same size (4:3, 16:9, etc.) as recorded in a DVD video disc.

#### Notes

- The displayable picture size is preset on the DVD video disc. Therefore, the playback picture of some DVD video discs may not conform to the picture size you select.
- When you play DVD video discs recorded in the 4:3 picture size only, the playback picture always appears in the 4:3 picture size regardless of the TV shape setting.
- If you select "16:9 Widescreen" and you own a 4:3 TV set, the DVD playback picture will be horizontally distorted during playback. Images will appear to be horizontally compressed. Always be sure that your TV shape conforms to the actual TV in use.
- Using the special functions to change the size of the displayed image (i.e. changing the height/width ratio) for the purpose of public display or commercial gain may infringe on copyright laws.

### Progressive 4:3 Output DVD-V VCD

Select the video output of pictures recorded in 4:3 format. (Only when connected to a PROGRESSIVE TV.)

**Full:** Displays pictures expanded horizontally to fill the 16:9 screen.

**4:3:** Displays images in 4:3 aspect ratio with masking bars to the left and right of the picture.

### Progressive Conversion DVD-V

There are two types of source content in pictures recorded in DVD video discs: film content (pictures recorded from films at 24 frames per second) and video content (video signals recorded at 30 frames per second). Make this selection according to the type of content being viewed.

- Auto:** Select this position normally. The player automatically detects source content, film or video, of playback source, and converts that signal in the progressive output format in an appropriate method.
- Video:** The player filters video signal, and converts it in the progressive output format appropriately. Suitable for playback of video content pictures.
- Film:** The player converts film content pictures in the progressive output format appropriately. Suitable for playback of film content pictures. The progressive output feature will be most effective under this selection.

#### Note

Depending on the disc, pictures may be cut off or doubled. In this case, select "Video."

### Pause/Still DVD-V

This is effective only for viewing playback pictures on the connected TV.

- Auto:** For normal use. Still and fast motion images can be paused.
- Frame:** The resolution of still pictures is improved, so that you can make a motionless picture more clearer when you pause it.

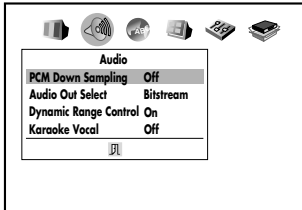

### PCM Down Sampling DVD-V DVD-A

Make this selection only when you use your audio equipment (e.g. receiver) connecting to the player via the BITSTREAM/PCM (DIGITAL) AUDIO OUT jack.

According to performance of your connected receiver, select a sound processing option for playback of a disc that contains high frequency signals (sampling frequency 96 kHz or 88.2 kHz).

**On:** Select when your connected receiver does not conform to high frequency signals of 88.2 kHz or higher.

The player outputs these signals in a disc depressing the frequencies to 48 kHz or 44.1 kHz.

**Off:** Select when your connected receiver conforms to high frequency signals of 88.2 kHz or higher. The player outputs these signals in a disc as they are.

#### Notes

- Regardless of this setting, the player outputs high frequency signals in a copyright protected disc, depressing to 48 kHz or 44.1 kHz; and outputs those of 176.4 kHz or 192 kHz in a disc with no copyright protection, depressing to 88.2 kHz or 96 kHz.
- If you select "Off" while your connected receiver does not conform to high frequency signals of 88.2 kHz or higher, you cannot hear output sound of those signals.

### Audio Out Select DVD-V DVD-A VCD CD

Select the output sound format corresponding to your system connection.

For details of sound recording systems, see [49](#).

**Bitstream:** Select when connected to an amplifier equipped with a Dolby Digital, DTS, MPEG1 or MPEG2 decoder. [82](#) [83](#)  
The player outputs digital audio information in the bitstream format when you play a DVD video disc recorded on the Dolby Digital, DTS, MPEG1 or MPEG2 recording system.

**PCM:** Select when connected to a 2 channel digital stereo amplifier. [84](#)  
The player outputs sounds in the PCM 2ch format when you play a DVD video disc recorded on the Dolby Digital, MPEG1 or MPEG2 recording system.

#### Note

When you make a connection to a TV, or Dolby Pro Logic or stereo system via the analog audio jacks, select "Bitstream" or "PCM."

# Customizing the Function Settings (continued)

## Setting details

### Dynamic Range Control DVD-V

Turn on or off a function that makes faint sounds easier to hear even if you lower the volume during late hours playback.

Off: Full dynamic range is maintained.  
 On: Dynamic range is reduced.

**Notes**

- This function works only during playback of Dolby Digital recorded discs.
- The level of Dynamic Range Reduction may differ depending on the DVD disc.

### Karaoke Vocal DVD-V

Off: The primary vocal is not output.  
 On: The primary vocal is output when it is recorded on the disc.

**Notes**

- The vocal output feature is used during playback of Dolby Digital (multi-channel) recorded DVD KARAOKE discs. This feature allows you to turn off vocal audio tracks, or restore them for background accompaniment.
- When playing KARAOKE, connect appropriate audio equipment such as an amplifier to the player.

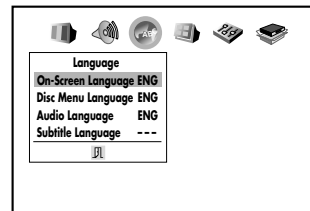

### On-Screen Language DVD-V DVD-A VCD CD

English: To view on-screen displays in English.  
 Français: To view on-screen displays in French.  
 Español: To view on-screen displays in Spanish.

### Disc Menu Language DVD-V

English: To display disc menus in English.  
 French: To display disc menus in French.  
 Spanish: To display disc menus in Spanish.  
 Others: To make a further choice.

After pressing the ENTER button, follow steps 1) - 4) below.

- 1) Obtain the abbreviation of the preferred language from the list [75].
- 2) Select the first character by pressing ▲ / ▼.
- 3) Press ◀ / ▶ to shift and select the second character by pressing ▲ / ▼.

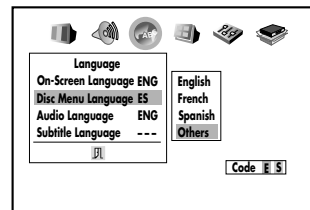

- 4) Press the ENTER button.

**Note**

Some DVD video discs may not include your pre-selected language. In this case, the player automatically displays disc menus consistent with the disc's initial language setting.

## Audio Language DVD-V

English: To play sound tracks in English.

French: To play sound tracks in French.

Spanish: To play sound tracks in Spanish.

Others: To make a further choice.

After pressing the ENTER button, follow steps 1) - 4) below.

- 1) Obtain the abbreviation of the preferred language from the list **[75]**.
- 2) Select the first character by pressing **▲ / ▼**.
- 3) Press **◀ / ▶** to shift and select the second character by pressing **▲ / ▼**.

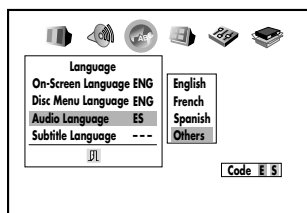

- 4) Press the ENTER button.

### Note

Some DVD video discs may be played in a different language than you selected. A prior language may be programmed on the disc.

## Subtitle Language DVD-V

English: To display subtitles in English.

French: To display subtitles in French.

Spanish: To display subtitles in Spanish.

No Subtitle: To disable subtitles.

Others: To make a further choice.

After pressing the ENTER button, follow steps 1) - 4) below.

- 1) Obtain the abbreviation of the preferred language from the list **[75]**.
- 2) Select the first character by pressing **▲ / ▼**.

- 3) Press **◀ / ▶** to shift and select the second character by pressing **▲ / ▼**.

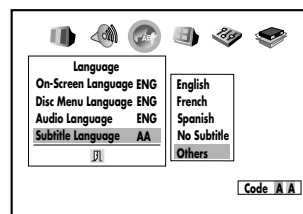

- 4) Press the ENTER button.

### Notes

- Some DVD video discs may be set to display subtitles in a different language than you selected. A prior subtitle language may be programmed on the disc.
- Some DVD video discs allow you to change subtitle selections only via the disc menu. If this is the case, press the MENU button and choose the appropriate subtitle language from the selection on the disc menu.

# Customizing the Function Settings (continued)

## Setting details

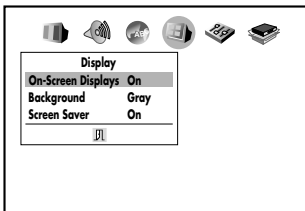

### On-Screen Displays DVD-V DVD-A VCD CD

- Off: Operational modes (e.g. "□□", "▷▷") are not displayed.
- On: Operational modes (e.g. "□□", "▷▷") are displayed on-screen.

### Background DVD-V DVD-A VCD CD

- Blue: Blue background.
- Gray: Gray background.
- Capture: To use a picture you sampled and stored in the memory using the Capture feature **[6]** as a background.
- Jacket: To use the jacket picture included on some discs as a background. If it is not included, a gray background will be substituted.

### Screen Saver DVD-V

- Off: The screen saver is disengaged.
- On: The screen saver operates.

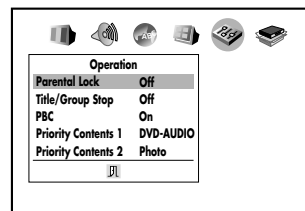
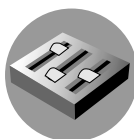

### Parental Lock DVD-V

DVD video discs equipped with the parental lock function are rated according to their content. The contents allowed by a parental lock level and the way a DVD video disc can be controlled may vary from disc to disc. For example, if the disc allowed you could edit out violent scenes unsuitable for children and replace them with more suitable scenes, or lock out playback of the disc altogether.

- DVD video discs may or may not respond to the parental lock settings. This is not a defect in the player. Make sure this function works with your DVD video discs.
- Off: The parental lock feature does not function. After pressing the ENTER button, follow step 1) below.
- On: To activate the parental lock feature or change the settings. After pressing the ENTER button, follow steps 1) - 3) below.

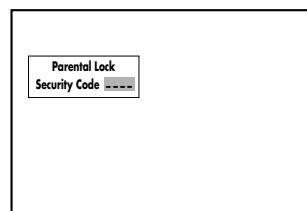



- 1) Press the number buttons to create a personal 4-digit security code, then press the ENTER button.

If you make a mistake before pressing the ENTER button, press CLEAR while pressing SHIFT and enter your 4-digit security code again.

- 2) Enter the code of a country/area whose standards were used to rate the DVD video disc, referring to the list below.

Country/Area	Code
AUSTRALIA	AU
BELGIUM	BE
CANADA	CA
CHINA	CN
CHINA HONG KONG	HK
DENMARK	DK
FINLAND	FI
FRANCE	FR
GERMANY	DE
INDONESIA	ID
ITALY	IT
JAPAN	JP
MALAYSIA	MY
NETHERLANDS	NL
NORWAY	NO
PHILIPPINES	PH
RUSSIAN FEDERATION	RU
SINGAPORE	SG
SPAIN	ES
SWEDEN	SE
SWITZERLAND	CH
TAIWAN	TW
THAILAND	TH
UNITED KINGDOM	GB
UNITED STATES	US

- a) Select the first character by pressing ▲ / ▼.
- b) Press ◀ / ▶ to shift and select the second character by pressing ▲ / ▼.
- c) Press the ENTER button.

- 3) Press ▲ / ▼ to select the parental lock level, then press the ENTER button.

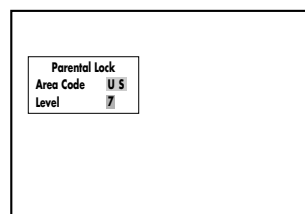

You cannot play DVD video discs rated higher than the level you selected unless you cancel the parental lock function.

For example, when you select level 7, discs rated higher than level 7 are locked out and cannot be played.

The parental lock level is equivalent to the following USA movie ratings.

- Level 7: NC-17
- Level 6: R
- Level 4: PG 13
- Level 3: PG
- Level 1: G

The parental lock levels for other countries/areas than U.S. are included for future use. Check the appropriate parental lock level when you buy a DVD video disc equipped with the parental lock feature in the future.

#### ■ To change the parental lock level

Follow steps 1) - 3).

#### ■ To change your 4-digit security code

- 1) After selecting "On" or "Off," press the STOP button four times, then press the ENTER button.

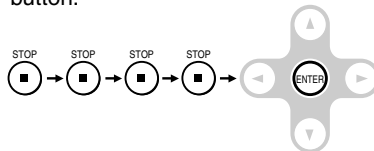

The 4-digit security code is cleared.

- 2) Press the number buttons to create a new 4-digit security code.
- 3) Press the ENTER button.

#### Note

After making the "Parental Lock" setting, the on-screen display will disappear. To make other settings, press the SETUP button again to display them.

# Customizing the Function Settings (continued)

## Setting details

### Title/Group Stop DVD-V | DVD-A

- Off: The player continues after playback of a title/group is completed.  
 On: The player stops after playback of a title/group is completed.

### PBC VCD

- Off: When playing a VIDEO CD without using the menu.  
 On: To use the menu when playing a PBC-featured VIDEO CD.

### Priority Contents 1 DVD-V | DVD-A

Select the playback priority between DVD video and DVD audio format signals when playing a DVD disc that contains both DVD video and DVD audio format signals.

- DVD-AUDIO: DVD audio format signals take priority over DVD video format signals.  
 DVD-VIDEO: DVD video format signals take priority over DVD audio format signals.

### Priority Contents 2

Select the playback priority between JPEG (picture) files and MP3/WMA (audio) files.

- Photo: JPEG files take priority over MP3/WMA files.  
 Audio: MP3/WMA files take priority over JPEG files.

#### Note

If this selection does not correspond to disc contents, the player will take a longer time to start playback of the disc.

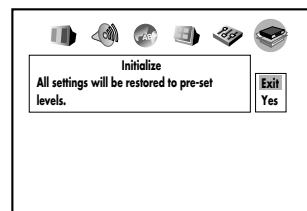
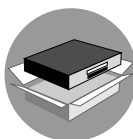

### Initialize DVD-V | DVD-A | VCD | CD

To restore all settings to the factory set.

- 1) Press **▲** / **▼** to select "Yes," and press the **ENTER** button.

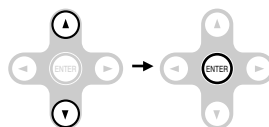

- 2) Read the message, and if you really want to restore all settings, press **▲** / **▼** to select "Yes," and press the **ENTER** button.

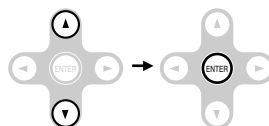

The message of completion appears.

#### Note

The "Parental Lock" setting and the background images taken by using the capture function are not restored to the factory set.

# Table of Languages

**Table of languages and their abbreviations**

Abbreviation	Language	Abbreviation	Language	Abbreviation	Language
---	No alternate language	GN	Guarani	PT	Portuguese
CHI (ZH)	Chinese	GU	Gujarati	QU	Quechua
DUT (NL)	Dutch	HA	Hausa	RM	Rhaeto-Romance
ENG (EN)	English	HI	Hindi	RN	Kirundi
FRE (FR)	French	HR	Croatian	RO	Rumanian
GER (DE)	German	HU	Hungarian	RU	Russian
ITA (IT)	Italian	HY	Armenian	RW	Kinyarwanda
JPN (JA)	Japanese	IA	Interlingua	SA	Sanskrit
KOR (KO)	Korean	IE	Interlingue	SD	Sindhi
MAY (MS)	Malay	IK	Inupiak	SG	Sango
SPA (ES)	Spanish	IN	Indonesian	SH	Serbo-Croatian
AA	Afar	IS	Icelandic	SI	Singhalese
AB	Abkhazian	IW	Hebrew	SK	Slovak
AF	Afrikaans	JI	Yiddish	SL	Slovenian
AM	Amharic	JW	Javanese	SM	Samoan
AR	Arabic	KA	Georgian	SN	Shona
AS	Assamese	KK	Kazakh	SO	Somali
AY	Aymara	KL	Greenlandic	SQ	Albanian
AZ	Azerbaijani	KM	Cambodian	SR	Serbian
BA	Bashkir	KN	Kannada	SS	Siswati
BE	Belorussian	KS	Kashmiri	ST	Sesotho
BG	Bulgarian	KU	Kurdish	SU	Sundanese
BH	Bihari	KY	Kirghiz	SV	Swedish
BI	Bislama	LA	Latin	SW	Swahili
BN	Bengali, Bangla	LN	Lingala	TA	Tamil
BO	Tibetan	LO	Laotian	TE	Telugu
BR	Breton	LT	Lithuanian	TG	Tajik
CA	Catalan	LV	Latvian, Lettish	TH	Thai
CO	Corsican	MG	Malagasy	TI	Tigrinya
CS	Czech	MI	Maori	TK	Turkmen
CY	Welsh	MK	Macedonian	TL	Tagalog
DA	Danish	ML	Malayalam	TN	Setswana
DZ	Bhutani	MN	Mongolian	TO	Tongan
EL	Greek	MO	Moldavian	TR	Turkish
EO	Esperanto	MR	Marathi	TS	Tsonga
ET	Estonian	MT	Maltese	TT	Tatar
EU	Basque	MY	Burmese	TW	Twi
FA	Persian	NA	Nauru	UK	Ukrainian
FI	Finnish	NE	Nepali	UR	Urdu
FJ	Fiji	NO	Norwegian	UZ	Uzbek
FO	Faroese	OC	Occitan	VI	Vietnamese
FY	Frisian	OM	(Afan) Oromo	VO	Volapük
GA	Irish	OR	Oriya	WO	Wolof
GD	Scottish Gaelic	PA	Panjabi	XH	Xhosa
GL	Galician	PL	Polish	YO	Yoruba
		PS	Pashto, Pushto	ZU	Zulu



# **Connections**

You can connect the player to a TV or audio system. Also, you can connect a battery pack to power the player.

- **Connecting to a TV**
- **Connecting to Headphones**
- **Viewing Pictures from Connected Video Equipment**
- **Connecting to Audio Equipment**
- **Using the Battery Pack**
- **Using the automobile/vehicle adapter or power port**

# Connecting to a TV

Connect the player to your TV.

For details of output sound, see **49**.

## Connecting to a TV

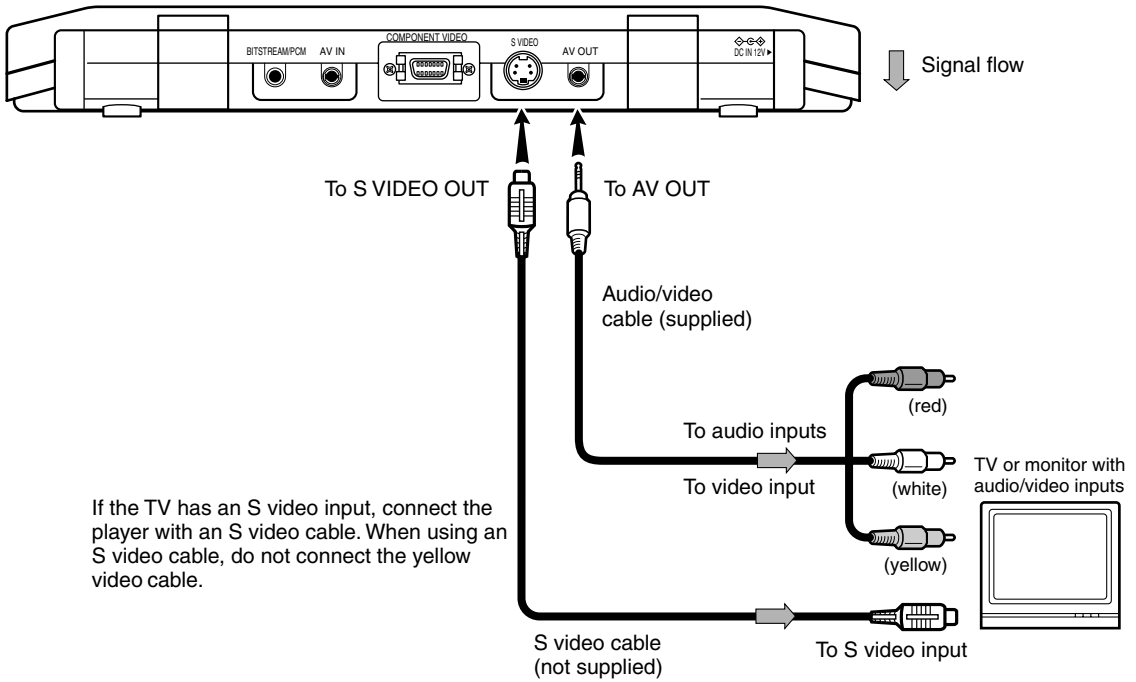

- Make the following setting.

On-screen display	Select:	Page
"Audio Out Select"	"Bitstream" or "PCM"	<b>66</b> <b>69</b>

### Notes

- Refer to the owner's manual of the connected TV as well.
- When you connect the player to your TV, be sure to turn off the power and unplug both units from the wall outlet before making any connections.
- Connect the player directly to your TV. If you connect the player to a VCR, TV/VCR combination or video selector, the playback picture may be distorted as DVD video discs are copy protected.

### INTERLACED outputs/inputs (ColorStream®)

Some TVs or monitors are equipped with component video inputs. Connecting to these inputs allows you to enjoy higher quality picture playback.

Actual labels for component video inputs may vary depending on the TV manufacturer. (ex. Y, R-Y, B-Y or Y, C<sub>B</sub>, C<sub>R</sub>)

In some TVs or monitors, the color levels of the playback picture may be reduced slightly or the tint may change. In such a case, adjust the TV or monitor for optimum performance.

### PROGRESSIVE outputs/inputs (ColorStream®Pro)

Some TVs or monitors are equipped with component video inputs that are capable of reproducing a progressively scanned video signal. Connecting to these inputs allows you to view the highest quality pictures with less flicker.

## Connecting to an audio system and TV equipped with component video inputs

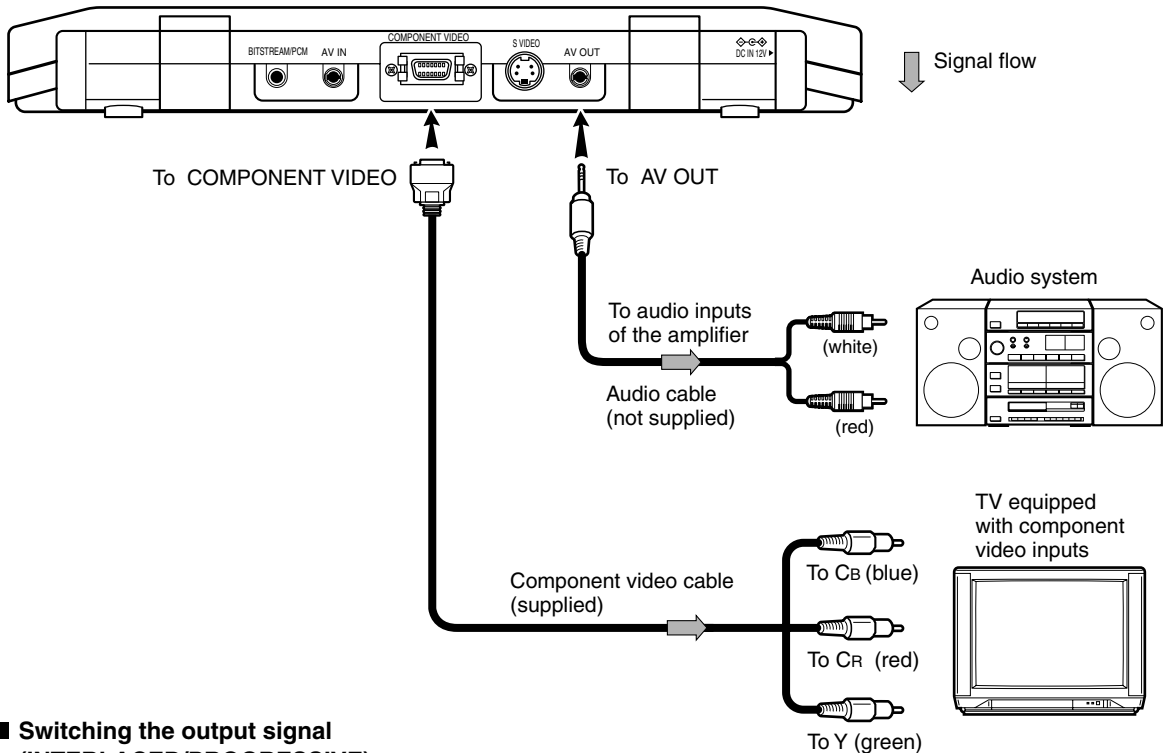

### Switching the output signal (INTERLACED/PROGRESSIVE)

Video signals of both interlace and progressive scanning formats are output from the player's COMPONENT VIDEO connector. Press the **MONITOR** button on the main unit repeatedly and select the type of output signal according to the scanning format of the connected TV. [23](#)

**MONITOR** Select "External Interlaced" or "External Progressive".

When the AV OUT or BITSTREAM/PCM jacks are connected to the audio input terminals of an audio system, sounds of discs can be heard on the connected audio system. For instructions on connections to audio systems, see [82](#).

- Make the following setting.

On-screen display	Select:	Page
"Audio Out Select"	"Bitstream" or "PCM"	<a href="#">66</a>
		<a href="#">69</a>

### Notes

- Refer to the owner's manual of the connected equipment as well.
- When you connect the player to other equipment, be sure to turn off the power and unplug all of the equipment from the wall outlet before making any connections.
- If you place the player near a tuner or radio, the radio broadcast sound might be distorted. In this case, place the player away from the tuner and radio.
- The output sound of the player has a wide dynamic range. Be sure to adjust the receiver's volume to a moderate listening level. Otherwise, the speakers may be damaged by a sudden high volume sound.
- Turn off the amplifier before you connect or disconnect the player's power cord. If you leave the amplifier power on, the speakers may be damaged.

## Connecting to Headphones

You can listen to movies and music privately by connecting headphones.

**Caution**  
When you use headphones, keep the volume at a moderate level. If you use the headphones continuously with high volume sound, it may cause hearing damage.

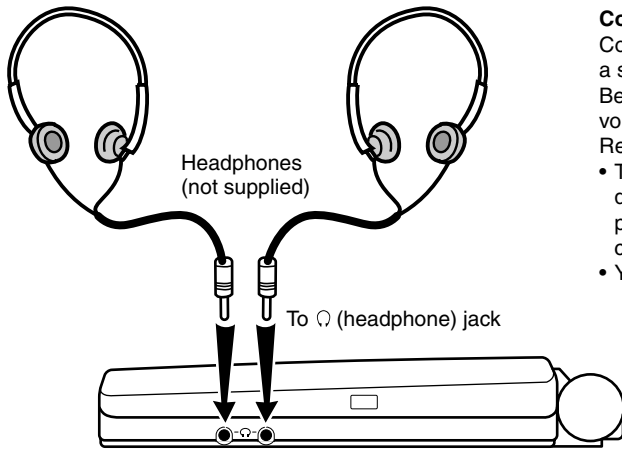

### Connecting headphones

Connect headphones to the headphone jack using a stereo mini plug.

Before connecting, temporarily turn down the volume with the headphone volume control. Readjust to your preference when playback starts.

- Turn off the player before you connect or disconnect the headphone cable. Possible shakes produced by plug connecting/disconnecting may cause damage to the disc.
- You can connect up to 2 headphones.

## Viewing Pictures From Connected Video Equipment

You can use the LCD of this player to monitor pictures of video equipment connected via the AV IN jack. Press the AV SOURCE button, then switch disc mode, card mode and external AV input mode. In the external AV input mode, screen saver function/auto power OFF function becomes ineffective.

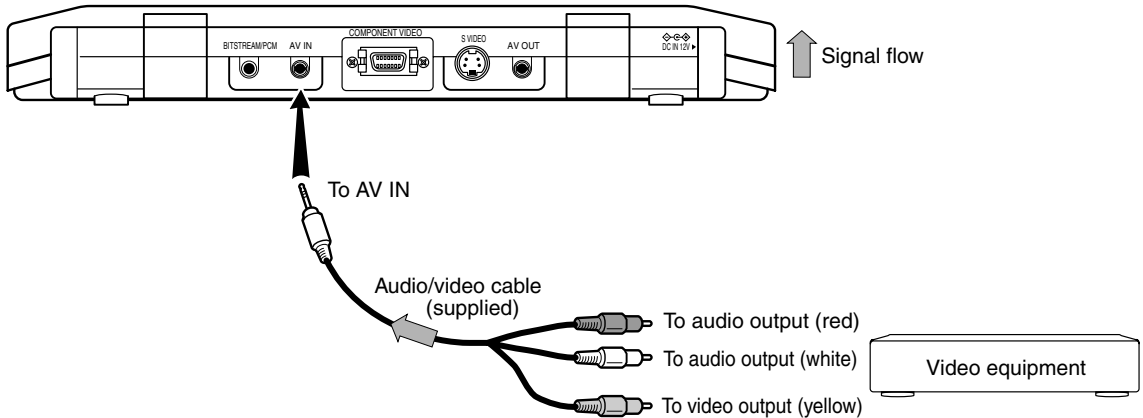

**Note**

When supplying non-standard signals such as playback images from a video deck or images from a game player, some images may be displayed incorrectly.



# Connecting to Audio Equipment

You can enjoy high quality dynamic sounds by connecting the player to audio equipment.

- For connection to your TV, see “Connecting to a TV” [78](#) [79](#).
- For details of output sound, see [49](#).
- This section uses the following reference marks.

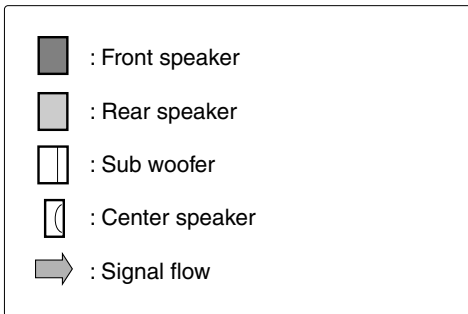

## Notes

- DO NOT connect the BITSTREAM/PCM (DIGITAL) AUDIO OUT jack of the player to the AC-3 RF input of a Dolby Digital Receiver. This input on your A/V Receiver is reserved for Laserdisc use only and is incompatible with the BITSTREAM/PCM (DIGITAL) AUDIO OUT jack of the player.
- Connect the BITSTREAM/PCM (DIGITAL) AUDIO OUT jack of the player to the “DIGITAL (OPTICAL)” or “DIGITAL (COAXIAL)” input of a Receiver or Processor.
- Refer to the owner’s manual of the connected equipment as well.
- When you connect the player to other equipment, be sure to turn off the power and unplug all of the equipment from the wall outlet before making any connections.
- The output sound of the player has a wide dynamic range. Be sure to adjust the receiver’s volume to a moderate listening level. Otherwise, the speakers may be damaged by a sudden high volume sound.
- Turn off the amplifier before you connect or disconnect the player’s power cord. If you leave the amplifier power on, the speakers may be damaged.

## Warning

- When you are connecting (via the BITSTREAM/PCM (DIGITAL) AUDIO OUT jack) an AV decoder that does not have Dolby Digital, Digital Theater Systems (DTS) or MPEG2 decoding function, be sure to set “Audio Out Select” to “PCM” from the on-screen displays [66](#) [69](#). Otherwise, high volume sound may damage your hearing as well as the speakers.
- When playing DTS-encoded discs (audio CDs), excessive noise may be output from the analog audio output jacks. To avoid possible damage to the audio system, you should take proper precautions when the analog audio output jacks of the player are connected to an amplification system. To enjoy DTS Digital Surround™ playback, an external 5.1 channel DTS Digital Surround™ decoder system must be connected to the BITSTREAM/PCM (DIGITAL) AUDIO OUT jack of the player.

# Connecting to Audio Equipment (continued)

## Connecting to an amplifier equipped with a Dolby Digital decoder

### Dolby Digital

Dolby Digital is the surround sound technology used in theaters showing the latest movies, and is now available to reproduce this realistic effect in the home. You can enjoy motion picture and live concert DVD video discs with this dynamic realistic sound by connecting the player to a 6 channel amplifier equipped with a Dolby Digital decoder or Dolby Digital processor. If you have a Dolby Surround Pro Logic decoder, you will obtain the full benefit of Pro Logic from the same DVD movies that provide full 5.1-channel Dolby Digital soundtracks, as well as from titles with the Dolby Surround mark.

Manufactured under license from Dolby Laboratories. "Dolby" and the double-D symbol are trademarks of Dolby Laboratories. Confidential unpublished works. ©1992-1997 Dolby Laboratories. All rights reserved.

- Use DVD video discs encoded via the Dolby Digital recording system.
- Make the following setting.

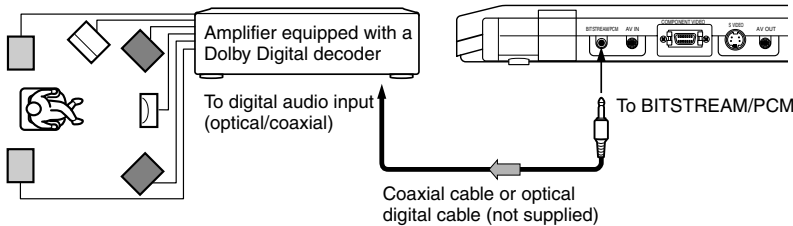

On-screen display	Select:	Page
"Audio Out Select"	"Bitstream"	<b>66</b>
		<b>69</b>
Recording system	<input checked="" type="checkbox"/> D	<b>49</b>

## Connecting to an amplifier equipped with Dolby Surround Pro Logic

### Dolby Surround Pro Logic

You can enjoy the dynamic realistic sound of Dolby Surround Pro Logic by connecting an amplifier and speaker system (right and left front speakers, a center speaker, and one or two rear speakers).

#### With an amplifier equipped with Dolby Digital

Connect the equipment the same way as described in "Connecting to an amplifier equipped with a Dolby Digital decoder." Refer to that amplifier's owner's manual and set the amplifier so you can enjoy Dolby Surround Pro Logic sound.

#### With an amplifier not equipped with Dolby Digital

Connect the equipment as follows.

- Make the following setting.

On-screen display	Select:	Page
"Audio Out Select"	"Bitstream" or "PCM"	<b>66</b>
		<b>69</b>

**Be sure to set "Audio Out Select" to "Bitstream" or "PCM" when you enjoy sounds of Dolby Surround Pro Logic using this connection.**

\* Connect one or two rear speakers. The output sound from the rear speakers will be monaural even if you connect two rear speakers.

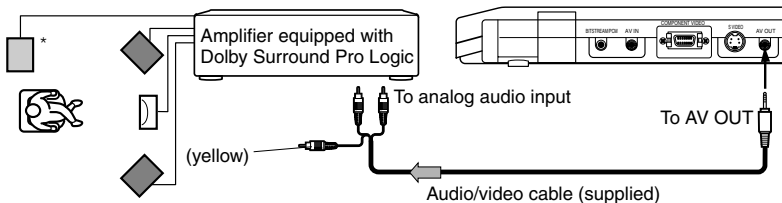

## Connecting to an amplifier equipped with a DTS decoder

### Digital Theater Systems (DTS)

DTS is a high quality surround technology used in theaters and now available for home use, on DVD video discs or audio CDs.

If you have a DTS decoder or processor, you can obtain the full benefit of 5.1 channel DTS encoded sound tracks on DVD video discs or audio CDs.

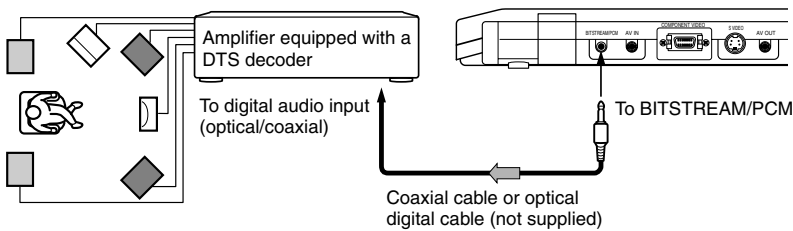

"DTS" and "DTS Digital Surround" are trademarks of Digital Theater Systems, Inc.

- Use DVD video discs or audio CDs encoded via the DTS recording system.
- Make the following setting.

On-screen display	Select:	Page
"Audio Out Select"	"Bitstream"	<b>66</b> <b>69</b>
Recording system	DTS	<b>49</b>

## Connecting to an amplifier equipped with an MPEG2 audio decoder

### MPEG2 sound

You can enjoy motion picture and live concert DVD video discs with dynamic realistic sound by connecting an amplifier equipped with an MPEG2 audio decoder or MPEG2 audio processor.

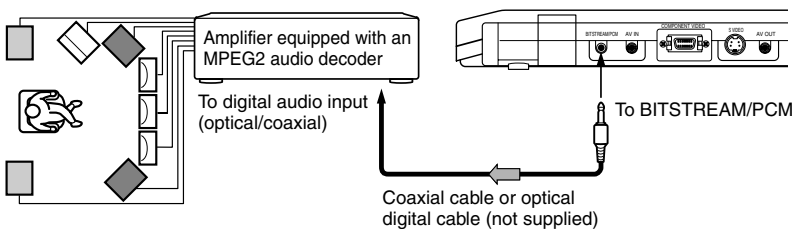

- Use DVD video discs encoded via the MPEG2 recording system.
- Make the following setting.

On-screen display	Select:	Page
"Audio Out Select"	"Bitstream"	<b>66</b> <b>69</b>
Recording system	MPEG2	<b>49</b>

# Connecting to Audio Equipment (continued)

## Connecting to an amplifier equipped with a digital audio input

### 2 channel digital stereo

You can enjoy the dynamic sound of 2 channel digital stereo by connecting an amplifier equipped with a digital audio input and speaker system (right and left front speakers).

- Make the following setting.

On-screen display	Select:	Page
"Audio Out Select"	"PCM"	<a href="#">66</a>
		<a href="#">69</a>

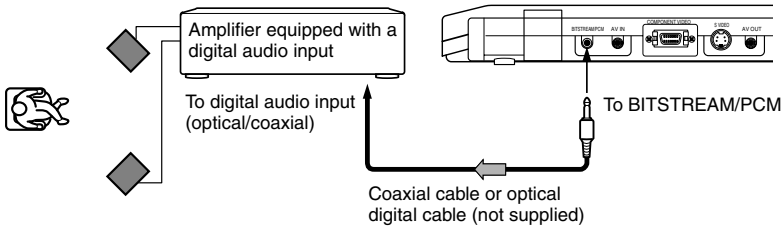

# Using the Battery Pack

## Warning

- Do not use a battery pack other than one specified as it can result in a fire or damage to the unit.
- Do not heat, open, or short-circuit the battery pack. Do not throw the battery pack into a fire. Doing so may cause an explosion or a fire.
- Attach the battery pack properly following the explanation below. Make sure that the battery pack is attached firmly to the player when using it. Otherwise, the battery pack may become detached and cause personal injury.

Use a battery pack MEDB04SX (supplied) or MEDB05LX (not supplied). Charge it before using.

## ■ Attaching the battery pack

First disconnect the AC adapter and the power cord from the player, then attach the battery pack.

- 1 Turn the player off.
- 2 Turn the player upside down.
- 3 Open the connector cover on the bottom of the player by sliding it.

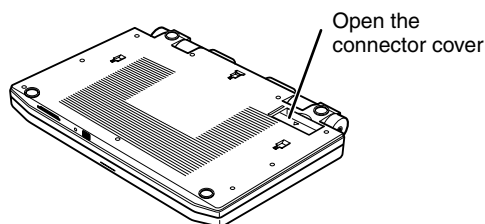

- 4 Turn the battery pack over and insert the connector hooks into the corresponding holes of the player. ① Then, slide the battery pack in the direction of the arrow ② until a "click" is heard.

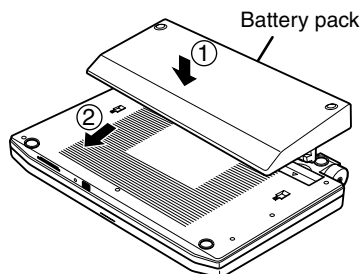

## Note

Remove the battery pack from the player after being used. If you leave the battery pack attached to the player even when the power is off, the battery will be drained.

## ■ Charging the battery pack

### 1 Turn the player off.

The battery pack will be charged only when the POWER to the player is turned OFF.

### 2 Attach the battery pack to the player.

### 3 Connect the supplied AC adapter and the power cord to the player. ⑱

Charging starts, and the POWER/CHG indicator illuminates in orange.

When the charging is completed, the POWER/CHG indicator turns off.

## Notes

- While the charge is in progress, do not disconnect the AC adapter and the power cord until the POWER/CHG indicator turns off.
- The attached battery pack may get warm when you are charging it or operating the player. This is not a defect.
- The POWER/CHG indicator flashes in green when the power in the battery pack is running low.
- Charge the battery with a surrounding temperature of +10°C to +30°C.
- Before charging the battery, neither its discharging nor exhausting is required.

## ■ Charging time of a battery pack

MEDB04SX (supplied)	approximately 3.0 hours
MEDB05LX (not supplied)	approximately 3.5 hours

The battery pack can be charged only when the DVD player is switched OFF. Charging time depends on environmental conditions.

## ■ LCD brightness while using the battery pack

Since the player operates in a power saving mode when the battery pack is attached, LCD brightness may be reduced. It can be restored by pressing the DIMMER button on the remote control. A brighter LCD display will shorten the playback time.

## ■ Continuous playback time while using the battery pack

MEDB04SX (supplied)	up to approximately 3.5 hours
MEDB05LX (not supplied)	up to approximately 5.0 hours

(Conditions: 25°C, output from the headphone, LCD brightness minimized, new battery pack in use.)

- Continuous playback time may vary depending on battery pack status, operational status and environment conditions.
- Low temperature will shorten the playback time.

## Using the Battery Pack (continued)

### ■ Displaying battery level

Press the QUICK button while playing a disc. The QUICK menu is displayed.  
Select "Battery" from the menu and one of the following icons are displayed in the left corner of the LCD screen.

▣▣▣▣ : Sufficient amount left

▣▣▣ : Fairly consumed

▣▣ : Nearly exhausted

▣ : Completely exhausted

When connected to an external input, press the QUICK button to view the battery level.

### ■ Detaching the battery pack

- 1 Turn the player off.
- 2 Disconnect the AC adapter and the power cord from the player.
- 3 Slide the battery pack's lock switch in the open direction, then slide the player in the direction of the arrow to remove it.

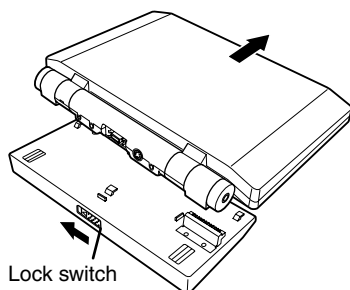

- 4 Close the connector cover on bottom of the player.

#### Note

Do not detach the battery pack while you are operating the player (while the POWER/CHG indicator illuminates in green).

### ■ About battery pack life

Battery pack has a duration life. When the playback time becomes remarkably shorter, even if the battery pack is fully charged, change to a new battery pack.

## Using the automobile/vehicle adapter or power port

For use of the DVD player in a car, this adapter can power the DVD player from the cigarette lighter socket.

### Warning

- NEVER operate the DVD player or view a DVD Video while operating an automobile or other vehicle. Note: doing so is illegal in many jurisdictions.  
NEVER place a DVD player within the eyesight of a driver while he/she is driving an automobile/vehicle. Note: A DVD player located in the front seating section of a vehicle is illegal in many jurisdictions.  
Failure to observe the above instructions could result in the driver's inattention to and/or distraction from road hazards.
- NEVER place a DVD player in a location where it could interfere with the proper deployment and/or performance of an air bag.  
Failure to observe this instruction could result in the prevention of an air bag to properly and/or effectively deploy.
- Do not use an adapter other than the model supplied, to power the player. Do not use the supplied vehicle adapter to power an apparatus other than this player. Neglecting these may cause smoke, fire or electrical shock to human body.
- This adapter is intended for exclusive use in automobiles/vehicles with a DC 12V negative ground electrical system. NEVER use this adapter with a DC 24V configured automobile/vehicle.  
Consult your vehicle owner's manual before using this adapter.
- ALWAYS use caution when touching the adapter, cigarette lighter socket or power port. The adapter, lighter socket and power port may become heated after prolonged use.
- Do not charge the battery pack which is attached to the DVD player by the adapter. Doing so may cause smoke, fire or electrical shock to human body. Whenever you use the adapter, be sure to remove the battery pack from the DVD player to prevent it being charged by the adapter.
- Do not touch the adapter with wet hands. Do not liquid over the adapter.

### Notes

- Never operate the player in a moving vehicle.  
Vibration may prevent proper playback of the player or cause damage to the disc.
- Do not leave the adapter in an unoccupied vehicle to avoid exposing it to unusually high ambient temperatures.
- Remove the adapter power plug from the cigarette lighter socket or power port before turning the engine off.
- When the DVD player is not in use be sure to remove the adapter power plug from the cigarette lighter socket or power port and the pin plug from the DVD player.
- Do not force the adapter into an incompatible lighter socket or power port.
- Avoid dropping the adapter or placing heavy objects on it.
- Do not pull the adapter power cord when removing it from a socket or power port.  
Always grasp and pull the body.  
Failure to do so could cause damage to and malfunction of the adapter.
- Do not operate the DVD player using the adapter for a prolonged period with the car engine off. The car battery may be too exhausted to turn the engine on.
- Depending on the vehicle model or the location of the cigarette lighter socket, this adapter may not be applied.

■ Instructions for Use

- 1 Turn off the DVD player.
- 2 Insert the pin plug of the adapter into the DC IN 12V jack of the DVD player.

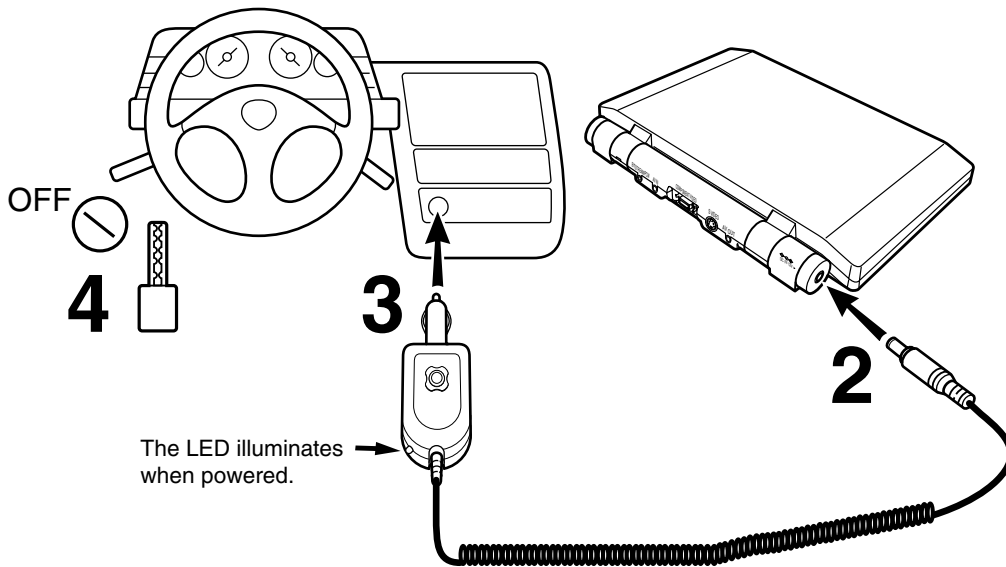

- 3 Insert the plug of the adapter into the cigarette lighter socket or power port fully.
- 4 Turn on the vehicle engine so that the cigarette lighter socket or power port is powered. In some vehicles the cigarette lighter socket or power port is powered even when the vehicle's engine is not running. It is important that the vehicle owner's manual be consulted.
- 5 When disconnecting the DVD player, first remove the adapter pin plug from the DVD player and then the power plug from the cigarette lighter socket or power port.

**Specification**

Operating temperature: 5 – 35°C  
Operating humidity: 30 – 80%  
Storage temperature: -10 – 60°C  
Storage humidity: 20 – 80%



# Others

- Before Calling Service Personnel
- Specifications
- LIMITED WARRANTY  
PORTABLE DVD PLAYER

## Before Calling Service Personnel

Check the following guide for the possible cause of a problem before contacting service.

### Symptoms and correction

Symptom	Cause	Correction	Page
No power.	• The AC adapter or power plug is disconnected.	• Connect the AC adapter or power plug securely.	<b>18</b>
	• The battery pack has been removed.	• Install the battery pack.	<b>85</b>
	• Battery empty.	• Re-charge the battery.	<b>85</b>
The player turned off by itself.	• The automatic power off function turned the unit off.	• Press the PLAY button.	<b>23</b>
No picture.	• The connected TV is not set to receive DVD signal output.	• Select the appropriate video input mode on the TV so the picture from the player appears on the TV screen.	<b>20</b>
	• The output signal is set to the External Screen mode.	• Set the output signal properly.	<b>23</b>
No sound.	• The equipment connected via the audio/video cable is not set to receive DVD signal output.	• Select the correct input mode of the audio receiver so you can listen to the sound from the player.	<b>78, 79</b>
	• The volume is too low.	• Adjust the volume by volume buttons.	<b>22</b>
	• The audio receiver or TV is turned off.	• Turn on the equipment connected with the audio/video cable.	<b>78 – 84</b>
	• The setting of output sound format is incorrect.	• Select the proper audio setting.	<b>48, 66 69</b>
The playback picture has occasional distortion.	• The disc is dirty.	• Eject the disc and clean it.	<b>8</b>
	• Player is in fast forward or fast reverse mode.	• Sometimes a small amount of picture distortion may appear. This is not a malfunction.	–
	• The main unit was moved or given a shock.	• Vibrating or shaking the unit during playback may produce distortion. This is not a malfunction. If not restored to usual status, stop playback and start again.	–
	• The disc is not set firmly.	• Remove the disc and set it again.	<b>20</b>
Brightness is unstable or noises are present in the playback pictures.	• The effect of copy protection.	• Connect the player directly to the TV. Avoid connecting the player to a VCR or TV/VCR combination.	<b>78</b>
The player does not start playback.	• No disc is inserted.	• Insert a disc.	<b>20</b>
	• An unplayable disc is inserted.	• Insert a playable disc. (Check the disc type, color system and region number.)	<b>10</b>
	• The disc is inserted upside down.	• Insert the disc with the playback side down.	<b>20</b>
	• The disc is not inserted securely.	• Insert the disc securely in the disc holder.	<b>20</b>
	• The disc is dirty.	• Clean the disc.	<b>8</b>
	• The parental lock function is set.	• Cancel the parental lock function or change the parental lock level.	<b>72</b>
Playback does not follow the course of the disc's program.	• It is in the repeat playback mode, memory playback, etc.	• These operations may prevent a proper progression of the contents.	–
Buttons do not work.	• Power supply fluctuations or other abnormalities such as static electricity may interrupt correct operation.	• Turn the power on or off with the POWER button. Or disconnect the power plug and insert it into the wall outlet again.	–
The remote control does not work properly.	• The remote control is not pointed at the remote sensor of the player.	• Point the remote control at the remote sensor of the player.	<b>17</b>
	• The remote control is too far from the player.	• Operate the remote control within about 3 m.	<b>17</b>
	• The batteries in the remote control are exhausted.	• Replace the batteries with new ones.	<b>17</b>

## Player / Connectors / Liquid crystal display / Supplied accessories

### Player

Power supply	DC 12 V (Rated current : 3 A (Maximum: during battery pack charging)) 120 V AC, 60 Hz (with the supplied AC adapter)
Mass	1000 g
External dimensions	259.8 × 30.1 × 179.8 mm (W/H/D)
Signal system	Standard NTSC
Laser	Semiconductor laser, wavelength 650 nm / 795 nm
Frequency range	DVD linear sound : 48 kHz sampling 4 Hz to 22 kHz 96 kHz sampling 4 Hz to 44 kHz 192 kHz sampling 4 Hz to 88 kHz
Operating conditions	Temperature: 5 °C to 35 °C, Operation status: Horizontal

### Connectors

Video output (AV OUT)	1.0 V (p-p), 75 Ω, negative sync., Ø3.5mm mini jack × 1
S video output (S VIDEO)	(Y) 1.0 V (p-p), 75 Ω, negative sync., Mini DIN 4-pin × 1 (C) 0.286 V (p-p), 75 Ω
Component video output (COMPONENT VIDEO)	D connector 14-pin, 2 lines, 1.27 mm pitch (Y): 1.0 V (p-p), 75 Ω, (Cb • Cr): 0.7 V (p-p), 75 Ω
Audio output (BITSTREAM/PCM)	Optical/coaxial connector (Ø3.5mm) × 1
Audio output (AV OUT)	1.5 V (rms), 220 Ω, Ø3.5mm mini jack × 1
Video input (AV IN)	1.0 V (p-p), 75 Ω, negative sync., Ø3.5mm mini jack × 1
Audio input (AV IN)	2.0 V (rms), Ø3.5mm mini jack × 1
Headphone terminal	Ø3.5mm stereo mini jack × 2

### Liquid crystal display

Panel size	8.9 inches
Projection system	TN color transmission
Driving system	Poly silicon TFT active matrix
Resolution	1024 (H) × 600 (V) pixels (effective pixel rate : more than 99.99%)

### Supplied accessories

Audio/video cable .....	1
Remote control (MEDR06UX) .....	1
Coin-shaped battery (CR2025) .....	1
AC adapter (ADP-36CH A) .....	1
Battery pack (MEDB04SX) .....	1
Component video cable .....	1
Power cord .....	1
Vehicle adapter .....	1

- Designs and specifications are subject to change without notice.

## LIMITED WARRANTY PORTABLE DVD PLAYER

---

Toshiba America Consumer Products, L.L.C. ("TACP") and Toshiba Canada Limited ("TCL") make the following limited warranties. These limited warranties extend to original consumer purchaser or any person receiving this set as a gift from the original consumer purchaser and to no other purchaser or transferee.

### Limited Ninety (90) Day Warranty

TACP/TCL warrant this product against defects in materials or workmanship for a period of ninety (90) days after the date of original retail purchase. During this period, TACP/TCL will repair a defective product or part, without charge to you. You must deliver the entire product to a TACP/TCL Authorized Service Station. You are responsible for all transportation and insurance charges for the unit to and from the Authorized Service Station.

### Limited One (1) Year Warranty

TACP/TCL further warrant the parts in this product against defects in materials or workmanship for a period of one (1) year after the date of original retail purchase. During this period, TACP/TCL will repair or replace a defective part, without charge to you, except that if a defective part is replaced after ninety (90) days from the date of the original retail purchase you pay labor charges involved in the replacement. You must also deliver the entire product to a TACP/TCL Authorized Service Station. You are responsible for all transportation and insurance charges for the unit to and from the Authorized Service Station.

### Rental Units

The warranty for rental units begin with the first rental or thirty (30) days from the date of shipment to the rental firm, whichever comes first.

### Commercial Units

Products sold and used for commercial use have a limited ninety (90) day warranty for all parts and labor.

### Owner's Manual

You should read the owner's manual thoroughly before operating this product. You should complete and mail the enclosed Demographic card within ten (10) days after you, or the person who has given you this product as a gift, purchased this product. This is one way to enable TACP/TCL to provide you with better customer service and improved products. Failure to return the card will not affect your rights under this warranty.

### Your Responsibility

The above warranties are subject to the following conditions:

- (1) You must retain your bill of sale or provide other proof of purchase.
- (2) You must notify a TACP/TCL Authorized Service Station within thirty (30) days after you discover a defective product or part.
- (3) All warranty servicing of this product must be made by a TACP/TCL Authorized Service Station.
- (4) U.S.A. warranties are effective only if the product is purchased and operated in the Continental U.S.A. or Puerto Rico.
- (5) Labor service charges for set installation. Set up, adjustment of customer controls and installation or repair of antenna systems are not covered by this warranty. Reception problems caused by inadequate antenna systems are your responsibility.
- (6) Warranties extend only to defects in materials or workmanship as limited above and do not extend to any product or parts which have been lost or discarded by you or to damage to products or parts caused by misuse, accident, damage caused by Acts of God, such as lighting or fluctuations in electric power, improper installation, improper maintenance or use in violation of instructions furnished by us; or to units which have been altered or modified without authorization of TACP/TCL or to damage to products or part thereof which have had the serial number removed, altered, defaced or rendered illegible.
- (7) Physically damaged DVD Units are not acceptable for repair or exchange whether in or out of warranty and will be returned as received.

## How to Obtain Service

- (1) Refer to the troubleshooting guide in your owner's manual. This checklist may solve your problem or check our web site at [WWW.TOSHIBA.COM/TACP](http://WWW.TOSHIBA.COM/TACP).
- (2) Products shipped to the Service Station must be insured and safely and securely packed, preferably in the original shipping carton, and a letter explaining the defect and also a copy of the bill of sale or other proof of purchase must be enclosed.

### In United States contact:

Toshiba America Consumer Products L.L.C.

(800)-631-3811

### In Canada contact:

Consumer Electronics Group

191 McNabb St  
Markham, Ontario L3R 8H2  
(905)-470-5400

Consumer Electronics Group

22171 Fraserwood Way  
Richmond, B.C. V6W 1J5  
(604)-303-2500

Toshiba of Canada Limited  
18050 Trans Canada Highway  
Kirkland, Quebec  
H9J 4A1  
(514)-390-7766

All warranties implied by state law, including the implied warranties of merchantability and fitness for a particular purpose, are expressly limited to the duration of the limited warranties set forth above. With the exception of any warranties implied by state law as hereby limited, the foregoing warranty is exclusive and in lieu of all other warranties, guarantees, agreements and similar obligations of manufacturer or seller with respect to the repair or replacement of any parts. In no event shall TACP be liable for consequential or incidental damages.

No person, agent, distributor, dealer or company is authorized to change, modify or extend the terms of these warranties in any manner whatsoever. The time within which an action must be commenced to enforce any obligation of TACP arising under the warranty or under any statute, or law of the United States or any state thereof, is hereby limited to ninety (90) days from the date you discover or should have discovered the defect. This limitation does not apply to implied warranties arising under state law.

This warranty gives you specific legal rights and you may also have other rights, which may vary from state to state. Some states do not allow limitation on how long an implied warranty lasts, when an action may be brought, or the exclusion or limitation of incidental or consequential damages, so the above provisions may not apply to you.

### ATTENTION CANADIAN CONSUMERS: (Toshiba Canada "TCL")

Canadian consumers are requested to complete the special Canadian "Warranty Registration Form" enclosed, and forward this completed form with a copy of bill of sale to TOSHIBA OF CANADA to "Register and Validate" their warranty. Product must be purchased from an Authorized Canadian Dealer.

### IMPORTANT: PACKING AND SHIPPING INSTRUCTION

When you send the product to a Service Station, you must use the original carton box and packing material, then insert the original carton box containing the unit into another carton, using more packing material.

**Products purchased in the U.S.A. and used in Canada are not covered by these warranties.**

**Products purchased in Canada and used in the U.S.A. are not covered by these warranties.**





**TOSHIBA**

Printed in China